



PERDIX

OPERATING INSTRUCTION

MANUAL



SHEARWATER

Powerful • Simple • Reliable

CONTENTS

INTRODUCTION	5
Models Covered by this Manual	5
Feature List.....	6
TURNING ON	7
BUTTONS	8
THE MAIN SCREEN	9
Color Coding	9
The Top Row.....	10
The Center Row	14
Center Row Configuration	15
The Bottom Row.....	16
INFO SCREENS	19
COMPASS (Perdix 2 only)	25
MENUS	28
Open Circuit Menu Structure.....	30
Closed Circuit (Int. PPO2) Menu Structure.....	31
Closed Circuit (Ext. PPO2) Menu Structure	32
BASIC SETUP	29
SIMPLE EXAMPLE DIVE	33
COMPLEX EXAMPLE DIVE	34
GAUGE MODE	38
Stopwatch	38
Resettable Average Depth.....	38
DECOMPRESSION AND GRADIENT FACTORS	39
MENU REFERENCE	41
Turn Off	41
Calibration.....	42
Single Sensor Mode.....	43
Calibration Problems.....	43
Switch Setpoint	44
Select Gas.....	45
Radio Station Gases	46
Select Gas Menu Styles	47
Switch to OC/CC	49
Dive Setup+	49
Low Setpoint.....	49
High Setpoint	50

CONTENTS

Define Gas	51
Dive Planner+	54
Conservatism.....	56
NDL Display	57
External PPO2 Monitoring	60
Brightness.....	62
Dive Log Menu.....	63
Display Log	63
Upload Log	63
Edit Log Number	63
System Setup+	65
Dive Setup.....	66
Deco Setup	68
OC Gases	68
CC Gases	68
O2 Setup.....	69
Auto SP (Setpoint) Switch.....	70
Display Setup	71
Compass Setup (Perdix 2 only)	73
System Setup	75
Advanced Configuration 1.....	76
Advanced Configuration 2	77
FIRMWARE UPLOAD	78
DIVE LOG DOWNLOAD	80
CHANGING THE BATTERY	82
Battery Types.....	83
TISSUES CLEARED	84
ERROR DISPLAYS.....	86
STORAGE AND MAINTENANCE.....	88
SERVICING	88
FISCHER PIN-OUT.....	88
SPECIFICATIONS.....	89
FCC WARNING	90
INDUSTRY CANADA WARNING.....	90
CONTACT	91



DANGER

This computer is capable of calculating deco stop requirements. These calculations are at best a guess of the real physiological decompression requirements. Dives requiring staged decompression are substantially more risky than dives that stay well within no-stop limits.

Diving with rebreathers and/or diving mixed gases and/or performing staged decompression dives and/or diving in overhead environments greatly increases the risk of scuba diving.

YOU REALLY ARE RISKING YOUR LIFE WITH THIS ACTIVITY.



WARNING

This computer has bugs. Although we haven't found them all yet, they are there. It is certain that there are things that this computer does that either we didn't think about, or planned for it to do something different. Never risk your life on only one source of information. Use a second computer or tables. If you choose to make riskier dives, obtain the proper training and work up to them slowly to gain experience.

This computer will fail. It is not whether it will fail but when it will fail. Do not depend on it. Always have a plan on how to handle failures. Automatic systems are no substitute for knowledge and training.

No technology will keep you alive. Knowledge, skill, and practiced procedures are your best defense (Except for not doing the dive, of course).



INTRODUCTION

The Shearwater Perdix is an advanced technical diving computer for open and closed circuit divers.

Although we strive to make the Perdix easy enough to use without reading the manual, please take some time to read this manual to get the best performance from your new computer. Diving involves risk and education is your best tool for managing this risk.

Models Covered by this Manual

This manual provides operating instructions for the Perdix.

FEATURE LIST



- Depth, time and oxygen sensor display
- Bühlmann decompression model with gradient factors conservatism
- Optional VPM-B decompression model
- Imperial and metric displays
- Available in Standalone (SA) model only
- A menu system that adapts to diving status
- Automatic turn off after 15 minutes on the surface
- Depth sensor functions past 300msw, crush pressure rating is 260msw (this is due to the case)
- Dive Planner
- Any combination of oxygen, nitrogen, and helium (Air, Nitrox, Trimix)
- Open and closed circuit, switchable during a dive
- 5 CC and 5 OC gases
- Gases can be changed and added during a dive
- CNS tracking
- No lockout from violating deco stops
- Automatic PPO2 set-point switching (configurable)
- Two PPO2 set-points, each of which can be set between .4 and 1.5
- Flexible user replaceable battery. Almost any 'AA' type
- Tilt compensated digital compass
- 1000 hour dive log memory
- Log downloads and firmware upgrades using Bluetooth

PERDIX INTRODUCTION

To see a video introduction to the Shearwater Perdix visit our YouTube page:

<https://youtu.be/j8Mxzl2u7Ow>



INSTALLING STRAPS OR BUNGEE CORD

The Perdix includes mounting points for either two elastic straps or two bungee cords. Both types are included in the box.

Straps

Install the elastic straps as shown in the image below. The buckles feature a locking mechanism to prevent them from inadvertently loosening. Press the tab to allow the buckle to slide freely on the straps. Strap width is 3/4" (19 mm).

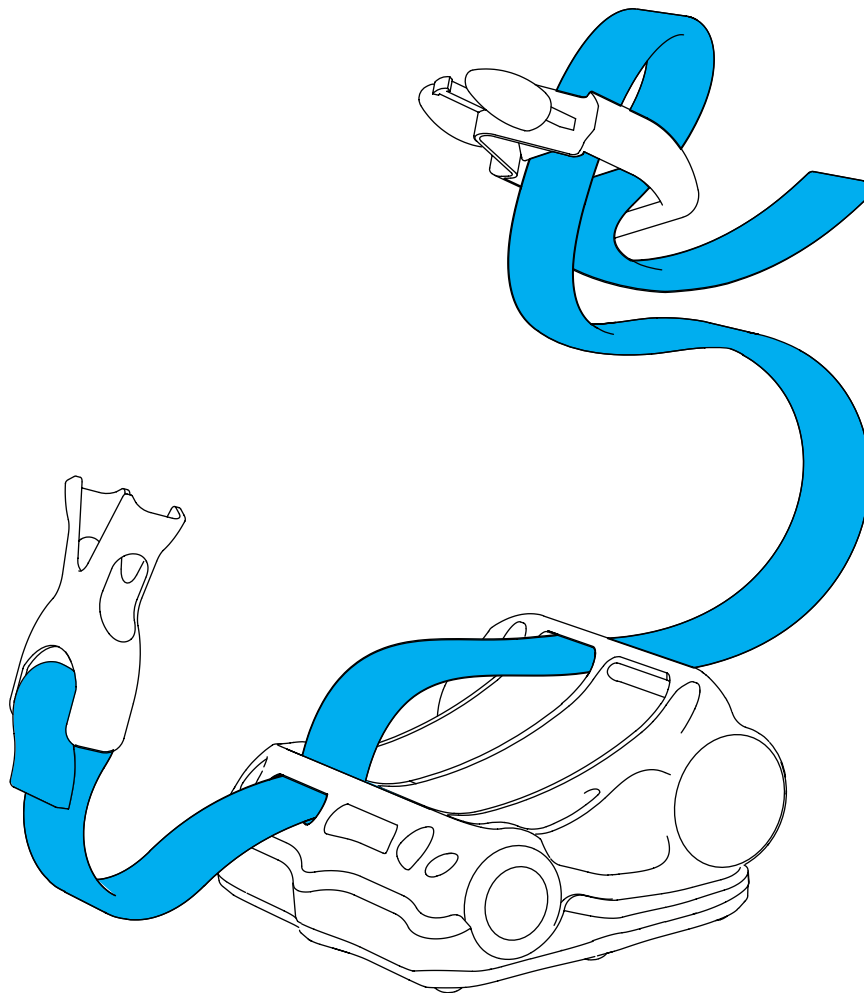

Install the straps and buckles as shown

BUNGEE CORD

Bungee cord can be installed in many ways based on your preference. Two examples are shown. The holes are sized for 3/16" (4.8 mm) diameter cord.

Allergy Alert! The supplied elastic surgical tubing contains LATEX.

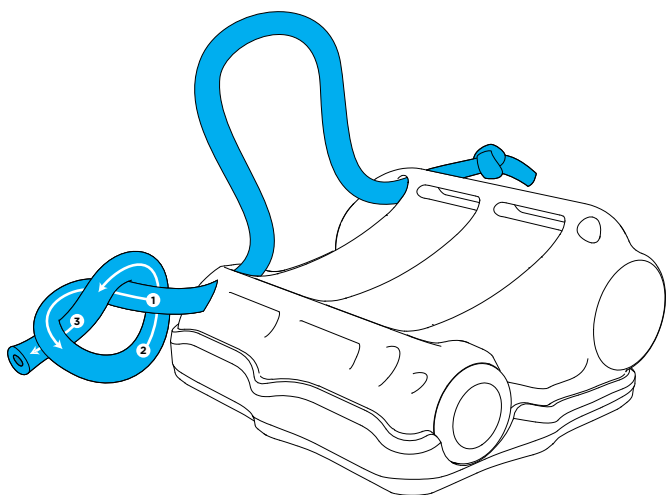

A simple overhand knot (at left) works well to secure the bungee cord.

However, this knot can pull through the mounting holes under very high load.

We find that the knot at right works well.

This knot has the nice feature of creating loops that stay wide open while putting the Perdix on your wrist.

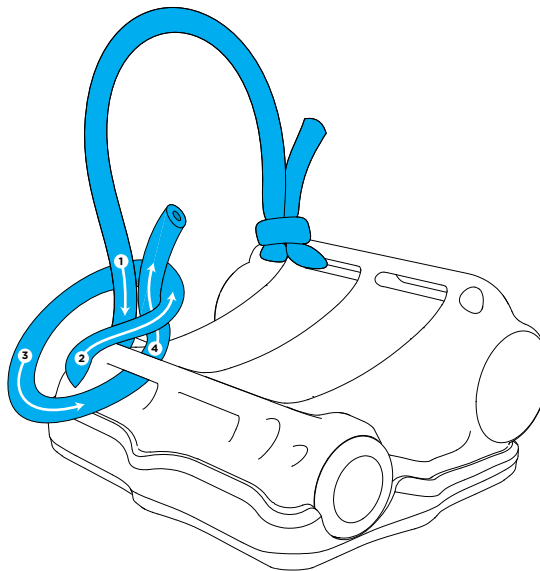

Tip: Use two pieces of cord

When using the bungee cord, always create two independent loops so that a single break does not result in a lost dive computer. If using a single continuous piece of cord, isolate the sides with a knot.

TURNING ON

To turn the Perdix on, press both the MENU (left) and the SELECT (right) buttons at the same time.



Auto-On

The Perdix will automatically turn-on when submerged underwater. This is based on pressure increase and not on the presence of water.



DO NOT RELY ON THE AUTO-ON FEATURE

This feature is supplied as a backup for when you forget to turn on your Perdix. Shearwater recommends turning on manually before each dive to confirm proper operation and to double check battery status and setup.

Auto-On Details

The Perdix turns on automatically when the absolute pressure is greater than 1100 millibar (mbar). For reference, normal sea level pressure is 1013 mbar and 1 mbar of pressure corresponds to approximately 1 cm (0.4") of water.

So the Perdix will automatically turn-on when about 0.9 m (3 ft) underwater when at sea level. If at higher altitude, then the Perdix auto-on will occur at a deeper depth. For example, when at 2000 m (6500 ft) altitude the atmospheric pressure is only about 800 mbar. Therefore, at this altitude the Perdix must be submerged underwater by 300 mbar to reach an absolute pressure of 1100 mbar. This means the auto-on occurs at about 3 m (10 ft) underwater when at an altitude of 2000 m.

BUTTONS

Two piezo-electric buttons are used to change settings and view menus.

 Except for turning the Perdix on, all operations are simple single button presses.



Don't worry about remembering all the button rules below. Button hints make using the Perdix easy.

MENU button (Left)

- From main screen > Brings up the menu
- In a menu > Moves to the next menu item
- Editing a setting > Changes the setting's value

SELECT button (Right)

- From main screen > Steps through information screens
- In a menu > Performs command or starts editing
- Editing a setting > Saves the setting's value



BOTH BUTTONS

When Perdix is off pressing MENU and SELECT at the same time will turn the Perdix on. No other operation requires pressing both buttons at the same time.

BUTTON HINTS

When in a menu, button hints label each button.

For example, the hints to the right tell us:

-  Use MENU to **change** the brightness value.
-  Use SELECT to **save** the current value.

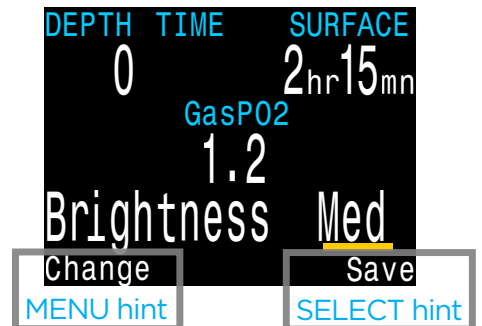

THE MAIN SCREEN

The main screen shows the most important information needed for technical diving.

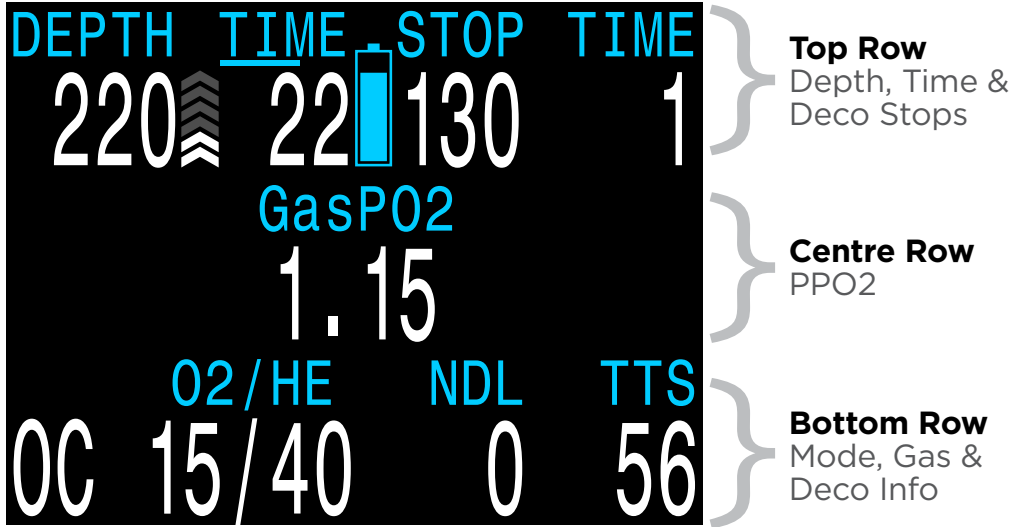

Colour Coding

Colour coding of text draws attention to problems or unsafe situations.

WHITE text indicates normal conditions.

YELLOW is used for warnings that are not immediately dangerous but should be addressed.

FLASHING RED is used for critical alerts that could be life threatening if not immediately addressed.



Sample warning - a better gas is available

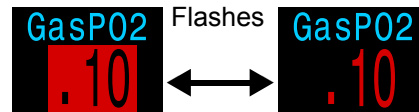

Sample critical alert - continuing to breathe this gas could be fatal

COLOR BLIND USERS

The warning or critical alert states can be determined without the use of color.

Warnings display on a solid inverted background. Warning - doesn't flash.

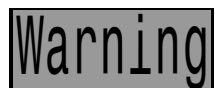

Critical alerts flash between inverted and normal text. Critical alert - flashes.

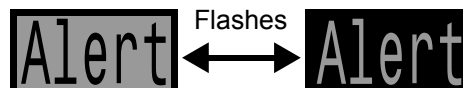

THE TOP ROW

The top row shows depth and time information



Depth

Imperial: In feet (no decimal places).

Metric: In meters (displays with 1 decimal place up to 99.9m)



Note: If the depth shows a Flashing Red zero or shows at depth at the surface, then the depth sensor needs service.

Ascent Bar Graph

Shows how fast you are currently ascending.

Imperial: 1 arrow per 10 feet per minute (fpm) of ascent rate.

Metric: 1 arrow per 3 meters per minute (mpm) of ascent rate.

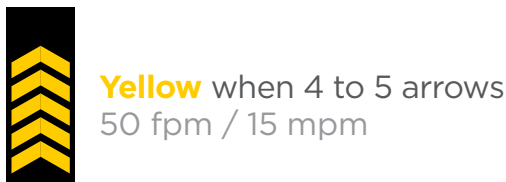
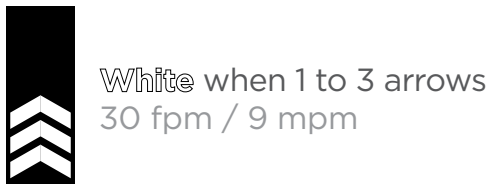

Note: Deco calculations assume 33fpm (10mpm) ascent rate.

Dive Time

The length of the current dive in minutes.

The seconds display as a bar drawn below the word "Time." It takes 15 seconds to underline each character in the word. Does not display the seconds bar when not diving.



Battery Icon

The default behavior is that the battery icon is shown on the surface but disappears when diving. If low or critical then the battery icon will appear while diving.

Yellow when the battery needs to be changed.

Red when the battery must be replaced immediately.

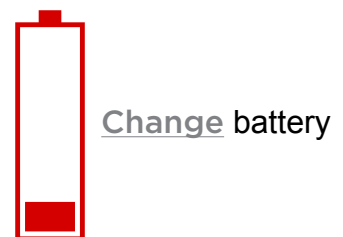
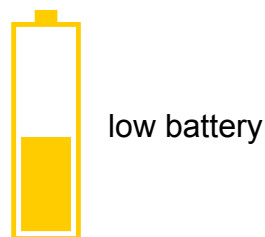

Stop Depth and Time

Stop - The next decompression stop depth in the current units (feet or meters). This is the shallowest depth to which you can ascend.

Time - The time in minutes to hold the stop.



STOP TIME
90 2

Stop at 90ft for 2 min

Will **Flash Red** if you ascend shallower than the current stop.



DEPTH TIME STOP TIME
84 62 90 2

Alert - depth is shallower than the 90ft stop depth

By default the Perdix uses a 10ft (3m) last stop depth. At this setting, you may perform the last stop at 20ft (6m) with no penalty. The only difference is that the predicted time-to-surface will be shorter than the actual TTS since off-gasing is occurring slower than expected.

There is also an option to set the last stop to 20ft (6m) if you wish.

Surface Interval

When on the surface, the STOP DEPTH and TIME are replaced by a surface interval display.

Shows the hours and minutes since the end of your last dive. Above 4 days, the surface interval is displayed in days.

The surface interval is reset when the decompression tissues are cleared. See the section on [Tissues Cleared](#).

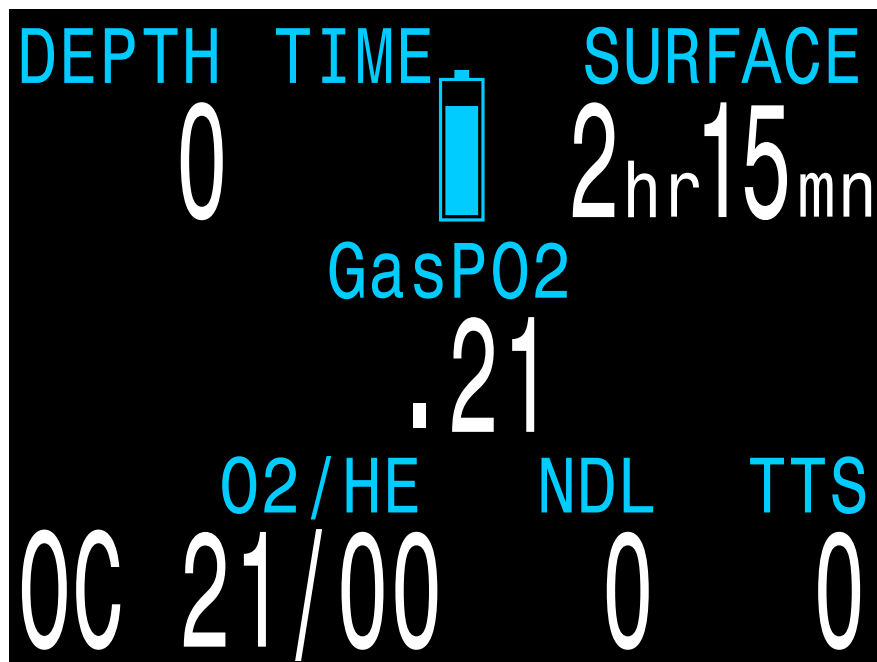

Sample surface main screen showing the surface interval

THE CENTER ROW

The center row displays PPO2. PPO2 units are absolute atmospheres (1ata = 1013mbar).

The layout varies depending on the current mode

Mode	Menu Setup	Center Row Display
Open Circuit		
Closed Circuit with Internal PPO2 Setpoints		

Note: The above limits can be adjusted in the [Adv. Config 2](#) menu.

Watch the video:
[Configurable Center Row](#)

Center Row Configuration

In most modes, the center row displays can be customized.

The center position can only display PPO2. In OC only mode, the PPO2 display can optionally be turned off.

Configure the center row in the System Setup → Center Row Menu.

The left and right positions can be set to display the following:

Centre Row	
Left	Max Depth
Center	Gas PPO2
Right	None
Next	Edit

Custom Display	DEPTH	TIME	STOP	TIME
	200	22	130	1
	MAX	GasP02		
	225 _{ft}	1.15		
	02/HE	NDL	TTS	
	00 15/40	0	56	

Option	Description
None	Blank (default value).
Max Depth	The maximum depth of the current or previous dive.
Avg Depth	The average depth of the current or previous dive.
@+5	The TTS if remaining at current depth for 5 more minutes.
Ceil	The current decompression ceiling (not rounded to the stop interval).
GF99	The Bühlmann ZHL-16C super-saturation percent gradient.
CNS	Central Nervous System (CNS) toxicity clock as a percentage.
Clock	The time-of-day in 24hr or am/pm format (same as system setting). Does not show "am" or "pm".
DET	Dive End Time. The time-of-day when the dive will end (i.e. Clock plus TTS). In 24hr or am/pm format (same as system setting). Does not show "am" or "pm".
Compass	A mini compass as an optional display. Works like a regular compass with the red end of the needle always points to North.
Timer	Timer (stopwatch) display.
Compass	A miniature compass. Works like a regular compass with the red end of the needle always points to North.

THE BOTTOM ROW

The bottom row displays the current mode, gas and decompression information.



Circuit Mode

The current breathing configuration. One of:



OC = Open circuit
(when CC available, displays in **Yellow** to indicate bailout condition)

CC = Closed circuit

Current Gas (O2/He)

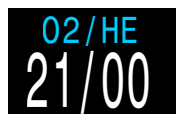

Air
 21% O2
 79% N2

The current gas shown as a percentage of Oxygen and Helium. The remainder of the gas is assumed to be Nitrogen.

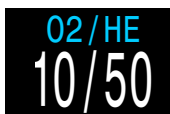

Tx
 10% O2
 50% He
 40% N2

In closed circuit mode, this gas is the diluent. In open circuit mode this is the breathing gas.

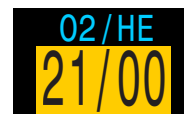

A better deco gas available

Displays in **Yellow** when there is better deco gas available than the current gas.

No Decompression Limit (NDL)

NDL
20

The time remaining, in minutes, at the current depth until decompression stops will be necessary. Displays in **Yellow** when the NDL is less than 5 minutes.

NDL
5

Once NDL reaches 0 (i.e. deco stops needed), the NDL display is just wasting space. To address this, a few different values can be set to replace the NDL (see [Dive Setup](#) → [NDL Display](#)). The options are listed below.

NDL Replacement Options

GF99
80%

GF99: The raw percentage of the Bühlmann allowable supersaturation at the current depth.

@+5
20

@+5: The predicted time-to-surface (TTS) if you were to stay at the current depth for 5 more minutes.

CEIL
74

CEIL: The current ceiling in the current units (feet or meters). **Flashes Red** if you ascend shallower than the current ceiling.

TTS
35

Time-to-Surface (TTS)

The time-to-surface in minutes. This is the current time to ascend to the surface including the ascent plus all required deco stops.

Assumes:

- Ascent rate of 33 feet per minute (10 meters per minute).
- Decompression stops will be followed.
- Programmed gases will be used as appropriate.

The bottom row is also used to show additional information.

By using only the bottom row for this additional information, the critical information contained on the Top and Center Rows is always available during a dive.

The additional information that can be displayed on the bottom row includes:

Info:

Shows additional dive information.

Info Screens:

Press SELECT (right button) to step through info screens.

Menus:

Allows changing settings.

Press MENU (left button) to enter menus.

Warnings:

Provide important alerts.

Press SELECT (right button) to clear a warning.

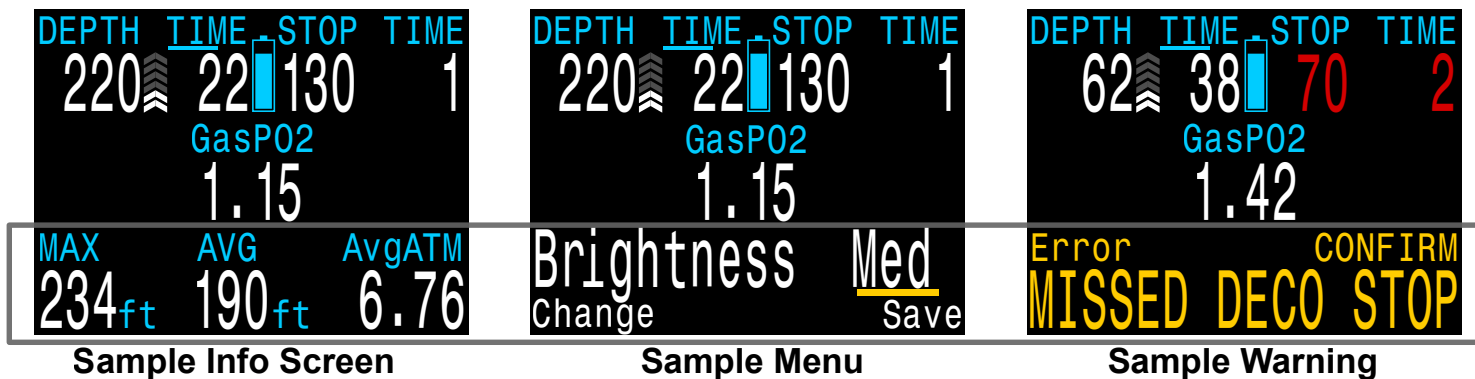

The bottom row is used to display additional information

INFO SCREENS

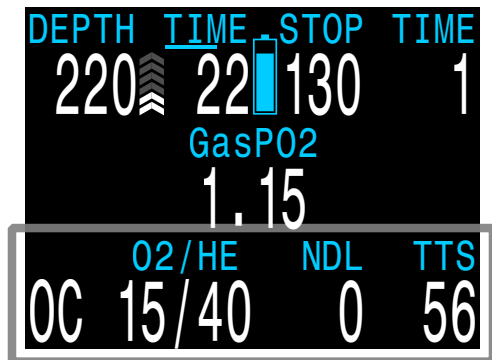

Info screens display on the bottom row.

Press SELECT (right) button to step through the info screens.

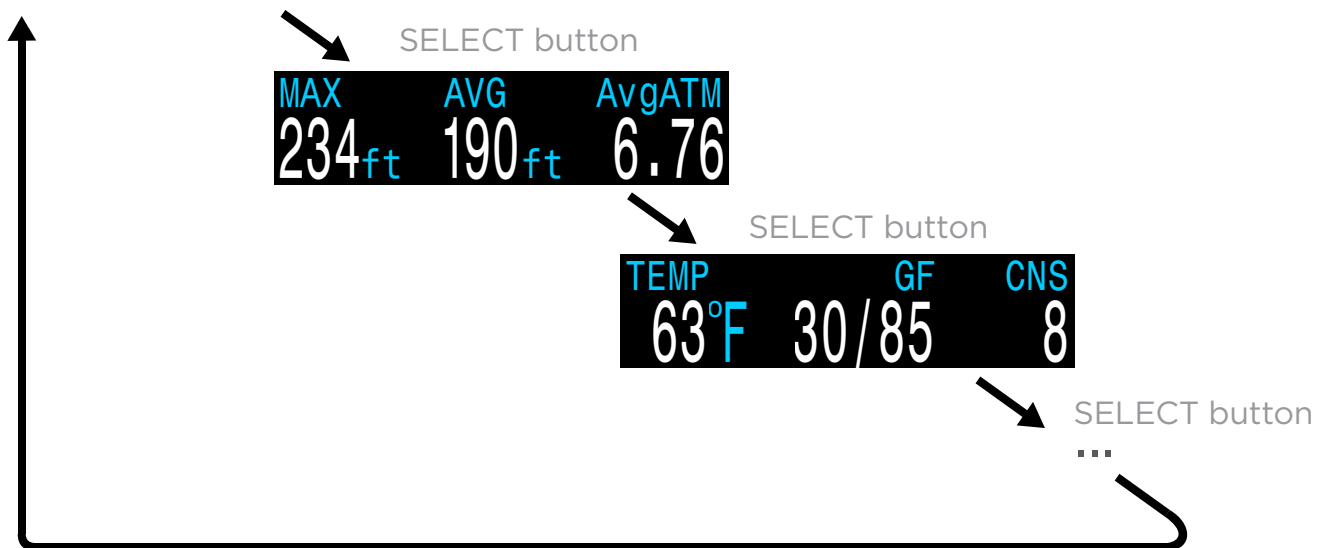

Info screens provide additional information that does not fit on the main screen.

Starting from the main screen, the SELECT (right) button steps through the info screens.

When all info screens have been viewed, pressing SELECT again will return to the main screen.

Info screens time-out after 10 seconds, returning to the main screen. Pressing the MENU (left) button will also return to the main screen.

The info screen content is optimized for each mode. Set the Perdix to the mode you will be using (e.g. OC) and step through the info screens to get familiar with the content.

The next section describes the individual values shown on the info screens.

AVG
50 ft

Average Depth

Displays the average depth of the current dive, updated once per second. When not diving, shows the average depth of the last dive.

AvgATM
2.52

Average Depth in Atmospheres (AvgATM)

The average depth of the current dive, measured in absolute atmospheres (i.e. a value of 1.0 at sea level). When not diving, shows the average depth of the last dive.

MAX
260 ft

Maximum Depth

The maximum depth of the current dive. When not diving, displays the maximum depth of the last dive.

CNS
11

CNS Toxicity Percentage

Central Nervous System oxygen toxicity loading percentage. Flashes Red when 100 or greater.

CNS
100

The CNS percentage is calculated continuously, even when on the surface and turned off. When deco tissues are reset, the CNS will also be reset.

CNS Toxicity Percentage Central Nervous System oxygen toxicity loading percentage. Flashes Red when 100 or greater.

The CNS percentage is calculated continuously, even when on the surface and turned off. When deco tissues are reset, the CNS will also be reset.

The CNS value (short for Central Nervous System Oxygen Toxicity) is a measure of how long you have been exposed to elevated partial pressures of oxygen (PPO2) as a percentage of a maximum allowable exposure time. As PPO2 goes up, the maximum allowable exposure time goes down. The table we use is from the NOAA Diving Manual (Fourth Edition).

During a dive the CNS never decreases. When back at the surface, a half-life of elimination of 90 minutes is used. So for example, if at the end of the dive the CNS was 80%, then 90 minutes later it will be 40%. In 90 more minutes it will be 20%, etc. Typically after about 6 half-life times (9 hours), everything is back close to equilibrium (0%).

A digital display showing 'PP02' in cyan and '.36' in red on a black background.

Also, when using external sensors and you have bailed out to OC, the center row continues to display the external measured PPO2. Use this info display to see the OC PPO2.

A digital display showing 'PP02' in cyan and '.16' in red on a black background.

In CC mode, displays in **Flashing Red** when less than 0.40 or greater than 1.6.

In OC mode, displays in **Flashing Red** when less than 0.19 or greater than 1.65.

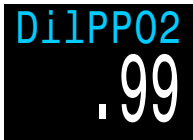
A digital display showing 'Di1PP02' in cyan and '.99' in white on a black background.

Diluent PPO2

Only displayed in CC mode. Displays in **Flashing Red** when the partial pressure of the diluent is less than 0.19 or greater than 1.65.

When performing a manual diluent flush, you can check this value to see what the expected PPO2 will be at the current depth.

A digital display showing 'FiO2' in cyan and '.42' in white on a black background.

Fraction Inspired O2 (FiO2)

The fraction of the breathing gas composed of O2. This value is independent of pressure.

Tissues Bar Graph



The tissues bar graph shows the tissue compartment inert gas tissue tensions based on the Bühlmann ZHL-16C model. Note that VPM-B also tracks tensions in the same way.

The fastest tissue compartment is shown on the top, and the slowest on the bottom. Each bar is the combined sum of the nitrogen and helium inert gas tensions. Pressure increases to the right.

The vertical black line shows the inert gas inspired pressure. The boundary between the green and yellow zones is the ambient pressure. The boundary between the yellow and red zone in the ZHL-16C M-Value pressure.

Note that the scale for each tissue compartment above the green zone is different. The reason the bars are scaled in this way is so that the tissues tensions can be visualized in terms of risk (i.e. how close they are as a percentage to Bühlmann's original supersaturation limits). Also, this scale changes with depth, since the M-Value line also changes with depth.

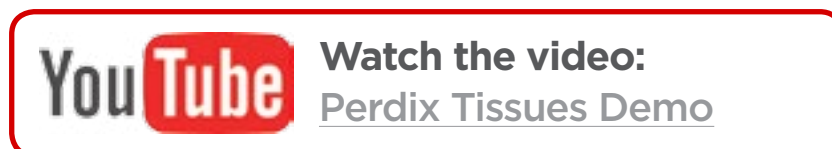

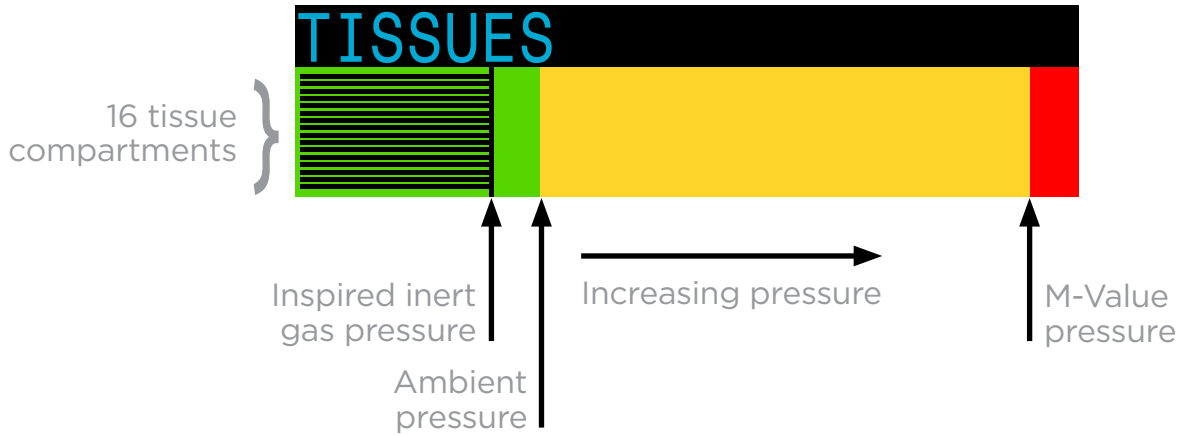

Sample Tissues Graphs



On surface (sat. with air)
 Note: Gas is 79% N₂ (21% O₂, or Air)



After descent



On-gassing



Deep stop



Last deco stop
 Note: Gas is now 50% O₂ and 50% N₂

GF
30/85

Gradient Factor:

The deco conservatism value when the deco model is set to GF. The low and high gradient factors control the conservatism of the Bühlmann GF algorithm. See “Clearing up the Confusion About Deep Stops” by Erik Baker.

VPM-B
+3

VPM-B (and VPM-BG):

The deco conservatism value when the deco model is set to VPM-B.

VPM-BG
+3/90

If the deco model is VPM-B/GFS, also displays the gradient factor for surfacing.

PRESSURE mBar
SURF 1013 NOW 1011

Pressure:

The pressure in millibars. Two values are shown, the surface (surf) pressure and the current (now) pressure. The current pressure is only shown on the surface. The surface pressure is set when the Perdix is turned on. If the Altitude setting is set to SeaLvl, then surface pressure is always 1013 millibars.

TEMP
73 °F

Temperature:

The current temperature in degrees Fahrenheit (when depth in feet) or degrees Celsius (when depth in meters).

BATTERY
3.7V 3.99V
LiIon

Battery:

The Perdix’s internal battery voltage. Displays in **Yellow** when the battery is low and needs replacement. Displays in **Flashing Red** when the battery is critically low and must be replaced as soon as possible. Also shows battery type.

DATE TIME DATE TIME
28-Jun-15 16:31 28-Jun-15 4:31pm

Date and Time:

In the format dd-mon-yy
12 or 24 hour clock time.

SERIAL NO VERSION
1234ABCD 2000029

Serial Number & Version:

Each Perdix has a unique serial number.

The version number indicates the available features. The last two numbers are the firmware version (V33 in this image).

COMPASS

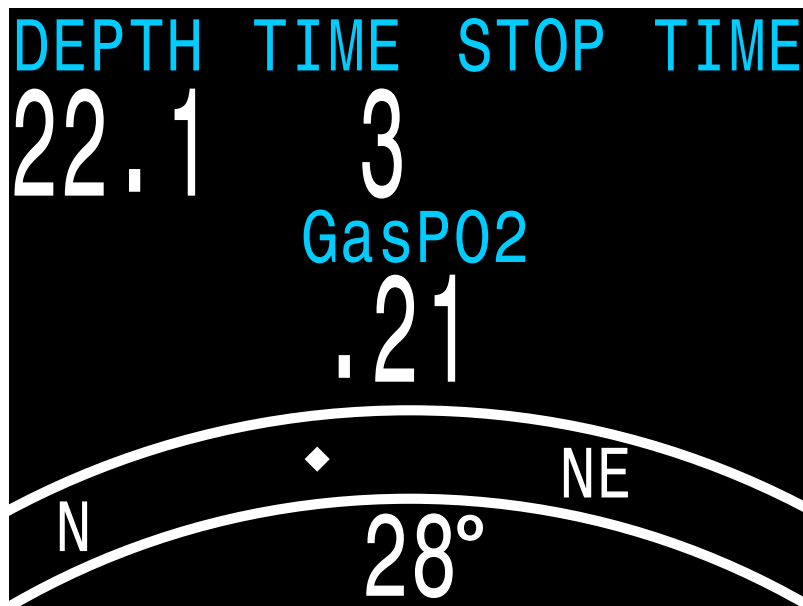

The Perdix model contains a tilt-compensated digital compass.

- Compass features:
- 1° resolution
- 35° accuracy
- Smooth, high-speed refresh rate
- User set heading marker with reciprocal
- True North (declination) adjustment
- Tilt compensation 345°

Viewing the Compass

When enabled, the compass is viewed by pressing the SELECT (right) button once. Press SELECT again to continue on to view the regular info screens.

Unlike the regular info screens, the compass never times out back to the main screen. Pressing the MENU (left) button brings up the Mark Heading option. Pressing MENU again returns to the main screen.



Compass

Marking a Heading

To mark a heading, when viewing the compass press the MENU (left) button. This brings up the "Exit Mark" menu. Press the SELECT (right) button to mark the heading.

The marked heading is shown with a green arrow. When within 35° of the heading, the degrees display turns green.

The reciprocal heading (180° from marked heading) is shown with a red arrow. When within 35° of the reciprocal heading, the degrees display turns red.

When more than 5° off the marked heading, a green arrow shows the direction back to the marked heading. Also, the offset degrees to the heading are displayed (16° in the example image). This offset is useful when navigating patterns. For example, a box pattern requires turns at 90° intervals, while a triangle pattern requires 120° turns.



COMPASS

It is important to understand some compass limitations before use.

Calibration:

The digital compass needs occasional calibration. This can be done in the [System Setup](#) → [Compass](#) menu and takes only one minute.

Battery Changes:

When the battery is changed, the compass should be calibrated. This is because each battery has its own magnetic signature that interacts with the compass. Fortunately this effect can be removed with proper calibration.

Interference:

Since a compass operates by reading the Earth's magnetic field, the compass heading is affected by anything that distorts that field or creates its own.

- Ferromagnetic materials (such as iron, steel, or nickel) should be kept away from the Perdix when using the compass.
- A traditional compass should also not be placed too close, as it contains a permanent magnet.
- Electric motors and high current cabling (such as from dive lights) can also cause interference and should be kept at a distance.
- Being inside or near a shipwreck may also affect the compass heading.



Watch the video:
[Compass Calibration](#)

MENUS

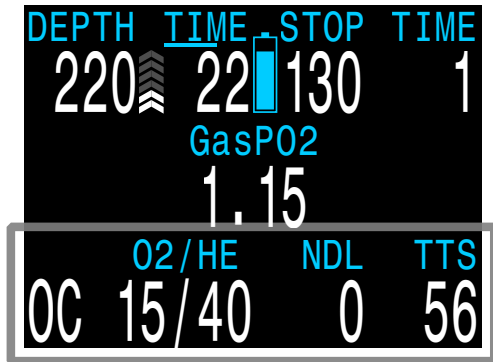

Press MENU (left) button to step through the menus.

Press SELECT (right) button to execute command or enter sub-menu.

Menus display on the bottom row.

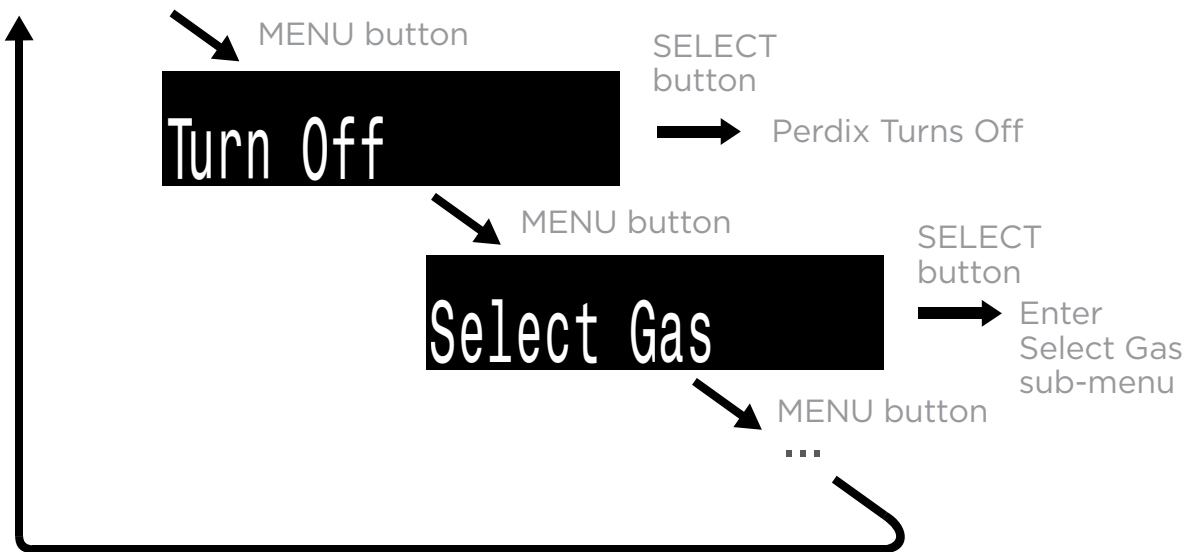

Menus perform actions and allow settings to be changed

Starting from the main screen, pressing the MENU (left) button steps through the menus. When all menus have been viewed, pressing MENU again will return to the main screen.

Pressing the SELECT (right) button when a menu is displayed, either performs that action or enters a sub-menu.

If no buttons are pushed for 1 minute, the menu system will time-out, returning to the main screen. Anything that had been previously saved will be retained. Anything that was in the middle of editing will be discarded.

 **ADAPTIVE MENUS**
 Only menus necessary for the current mode are shown. This keeps operation simple, prevents mistakes, and reduces buttons presses.

The following sections show the menu structure in various operating modes.

OPEN CIRCUIT MENU STRUCTURE

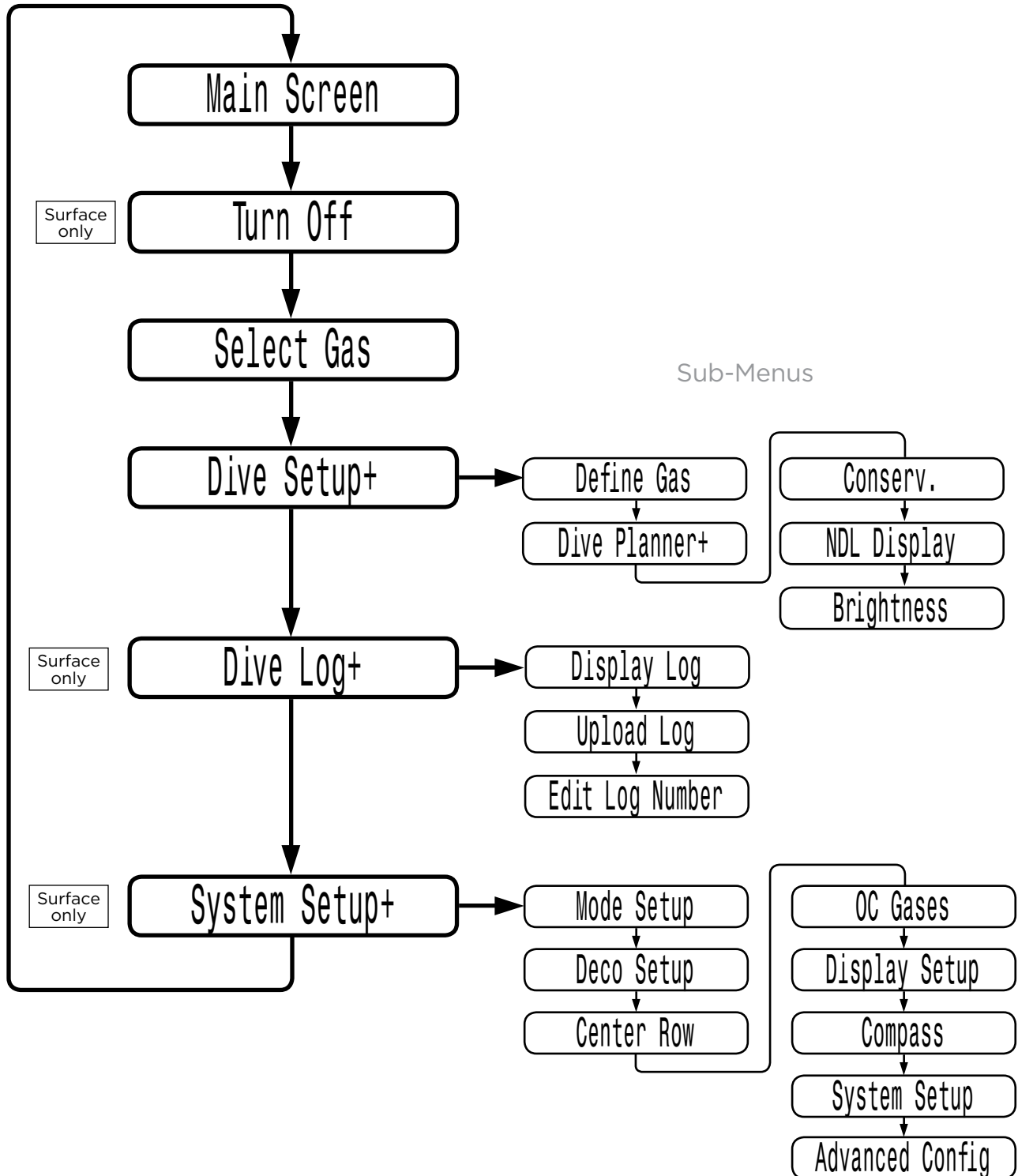

CLOSED CIRCUIT (INT. PPO2) MENU STRUCTURE

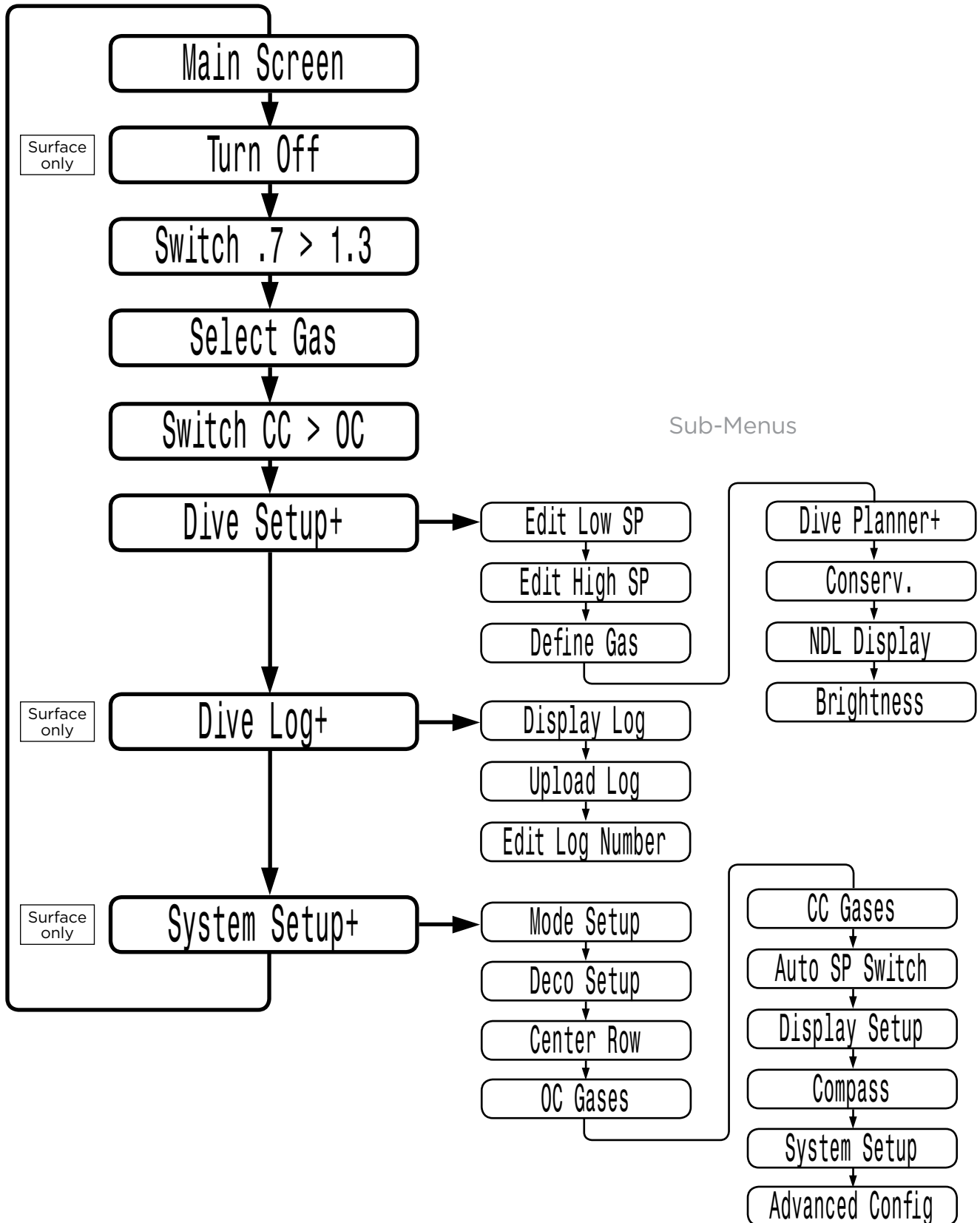

SIMPLE EXAMPLE DIVE



Watch the video:
[Air - Dive](#)

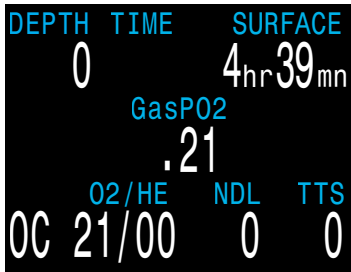

Here is an example of a simple OC air dive. It will help to introduce the screen displays as the diver progresses, the dive starts, the depth increases. The display is showing the computer programmed for open circuit (OC) air.

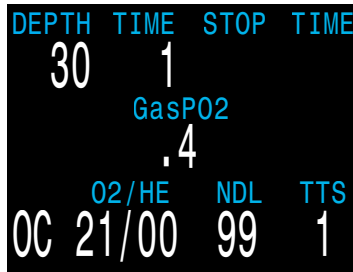

As we pass through 30 feet, the time-to-surface (TTS) shows one minute. This shows that the computer is expecting the diver to ascend at approximately 33 feet per minute or 10 meters per minute. The dive predictions are based on this ascent rate.



The no-decompression limit (NDL) starts off showing 99, but then starts to show a smaller number as the depth increases. The 3rd screen shows that we will go into deco in 12 minutes.

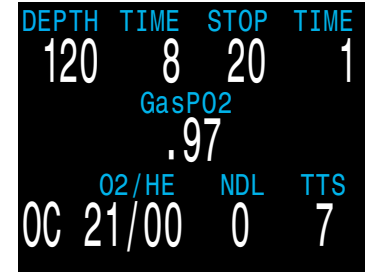

We have now entered decompression. Our first stop, or ceiling, is at 20 feet and we will need to remain there for up to one minute. Although stops are shown in minutes, the computer will calculate and change the ceiling in real time and the stop may be less than a minute.



As we ascend, the ascent rate indicator shows about 20 fpm or 6 mpm.

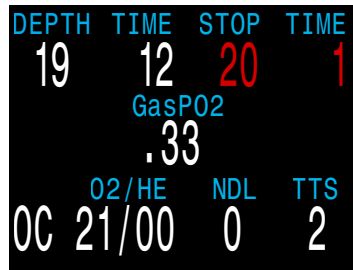

When we go shallower than our first stop, the stop depth starts to flash **red**.

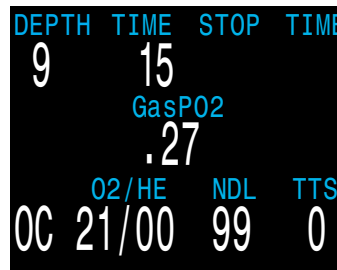

When we clear the last stop, the stop depth and time goes blank, and now we see a NDL of 99 minutes again. Once we surface, the depth is 0 and a minute later when the computer comes out of dive mode, the NDL goes to 0 as well.

COMPLEX EXAMPLE DIVE



Watch the video:
[Deco Dive](#)

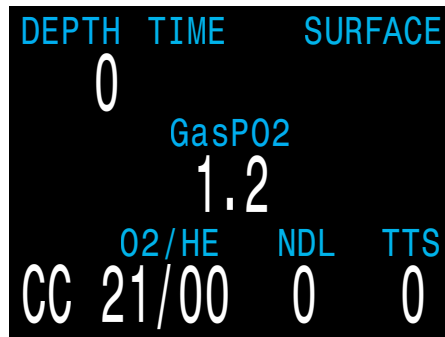
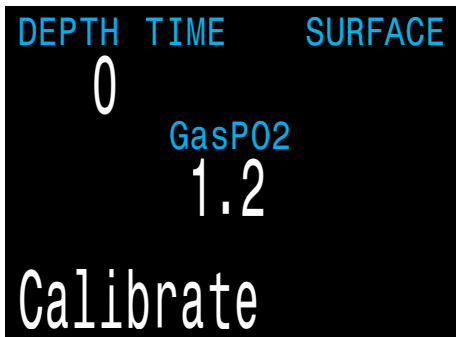

This is an example of the displays that might be seen on a dive. This example shows a complicated dive with multiple Closed Circuit (CC) gases and multiple Open Circuit (OC) bail-out gases. A normal, single gas CC or OC dive wouldn't have any button pushes at all, so there isn't much to show.

Next, we check the closed circuit diluent gases that we have programmed. Entering the gas selection function by pressing SELECT with the “Select Gas” menu item showing will display the first CC gas that is available. MENU will increment to the next gas available. Another MENU takes us back to the “Select Gas” menu item. Those are the only two gases configured. We SELECT gas number 2, the Trimix 10/50.

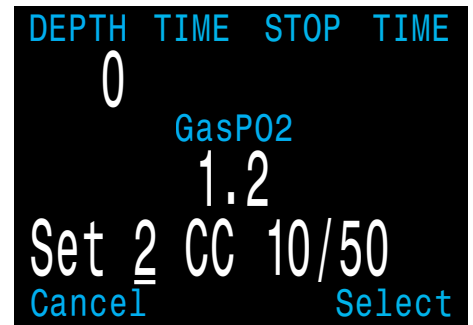
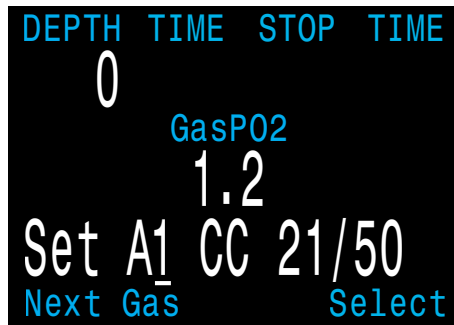
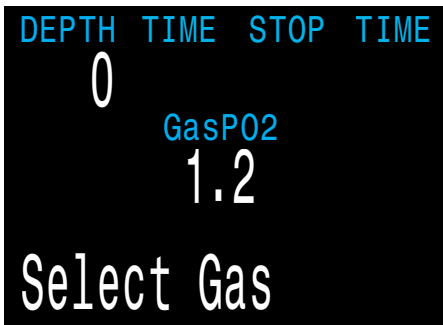

The system will use both of these gases for our dive when calculating the TTS. It assumes a diluent switch at a PPO2 of 1.05. That means that it will assume that you have switched to an air diluent at 124 feet. This is only for the TTS prediction. The computer will always use the currently selected gas for tissue loading calculations.

Then we switch to open circuit to look at our bail-out gases. Flipping through the gases with MENU shows that we have three gases available. (Whether they are appropriate gases is a subject for one of the web forums.)

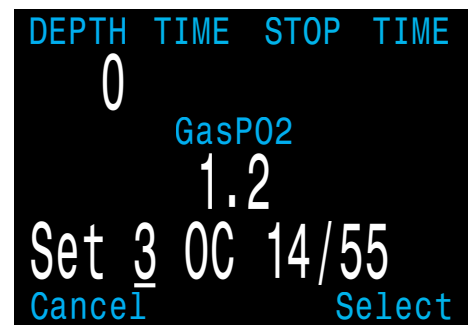
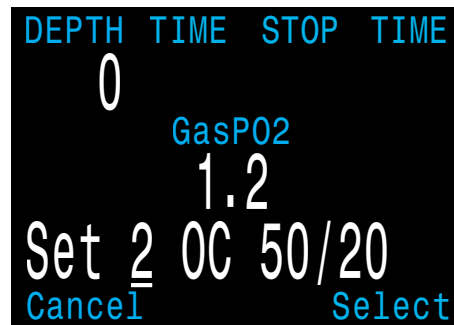
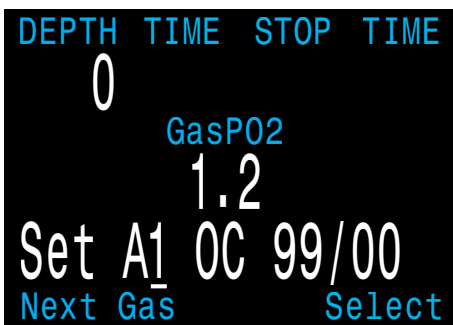

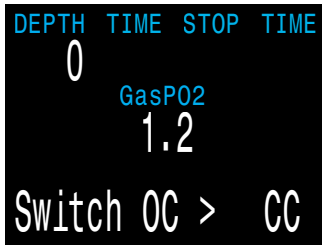

These are the gases that will be used to estimate TTS in the event that you switch to open circuit during a dive. In OC mode, the computer will assume that you will switch gases when the PPO2 of the next available gas is less than 1.6.

Automatic decisions of when to switch gases for the TTS calculation means that it is very easy to set up your CC and OC gases. There is no need to enter a depth or a PPO2 to switch gas. Any gases that are turned on will be used in the decompression calculation.

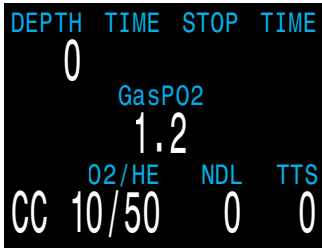

If a gas is available in the CC gas list, (entered and turned on), it will be used in CC, and it will be used at an appropriate depth. The same is true for OC. It is always configured correctly if you are actually carrying the gases you have entered and turned on.

If it is necessary to switch to OC while diving, 4 button pushes will do it. You will be switched to OC and will be using the gas that has the highest PPO2 less than 1.61. Your OC gas list is likely very different from your diluent gas list, but you set it up before the dive so it is immediately available in the case of a bail-out. Now switch back to closed circuit and start the dive.

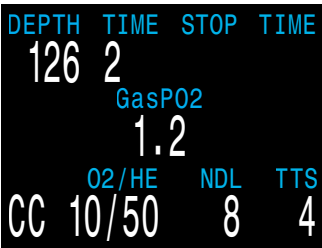

We have reached a depth now that will incur decompression soon. The NDL is 8 minutes, and the TTS is 4 minutes. The TTS is showing the planned ascent time at 30 fpm.

The computer has automatically switched to the high setpoint. This can be disabled if automatic setpoint switching isn't required.

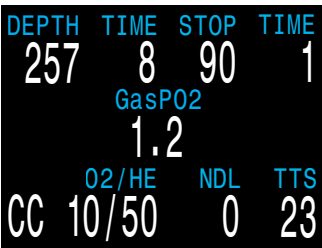

We are now at our maximum depth. Our first stop is at 90 feet.



The diver is ascending to the 90 foot stop. Note the ascent rate indicator showing a 20 fpm / 6 mpm ascent rate. The Perdix assumes a 30 fpm ascent rate in calculating the decompression schedule. Since the diver ascended slower than predicted there is now a 100 foot stop.

```

DEPTH  TIME  STOP  TIME
 95    15    100   1
GasPO2
 1.2
O2/HE  NDL  TTS
CC 10/50  0  22
    
```

But the diver missed the stop, and has ascended to 95 feet. At this point, the stop depth and time is flashing **red** to show that the depth is above the recommended stop.

```

DEPTH  TIME  STOP  TIME
 95    15    90    1
GasPO2
 1.2
O2/HE  NDL  TTS
CC 21/50  0  22
    
```

The diver switches to the other programmed CC gas. Note that if you change the diluent on the computer you must flush the loop to change the diluent in the loop. At the same time the 100 foot stop clears. It is common for the first stops to clear in less than a minute. They mainly just slow down the ascent.

```

DEPTH  TIME  STOP  TIME
 60    19    60    1
GasPO2
 1.2
Select Gas
    
```

At 60 feet a problem develops that causes the diver to bail out to open circuit. The first push on MENU brings up Select Gas.

```

DEPTH  TIME  STOP  TIME
 60    19    60    1
GasPO2
 1.2
Switch CC > OC
    
```

The second push brings up Switch CC > OC. A push on SELECT does the switch.

Note that OC displays in **Yellow** to clearly indicate that this is a OC bailout condition.

```

DEPTH  TIME  STOP  TIME
 60    19    60    1
GasPO2
 1.2
OC 50/20  0  36
    
```

The system has switched the gas set from the closed circuit gas set to the open circuit gas set, picked the gas with the highest PPO2 less than 1.6, and recalculated the decompression based on the new profile.

```

DEPTH  TIME  STOP  TIME
 20    25    20    3
GasPO2
 1.2
O2/HE  NDL  TTS
Select Gas
    
```

At 20 feet, one push on MENU brings up select gas.

```

DEPTH  TIME  STOP  TIME
 20    25    20    3
GasPO2
 1.2
Set 1 OC 99/00
Cancel          Select
    
```

A push on SELECT enters the select gas menu, and another SELECT picks the O2. Since the gases are sorted by oxygen content, the O2 is the first gas offered.

This was a multi-gas trimix dive with a multi-gas open circuit bailout, and it required 9 button pushes.

GAUGE MODE

Gauge Mode turns the Perdix into a simple depth and time display (a.k.a. a bottom timer).

Change to Gauge Mode in the [System Setup](#) → [Dive Setup](#) menu.

Since decompression tissues are not tracked in Gauge Mode, changing to or from Gauge Mode resets the deco tissues.

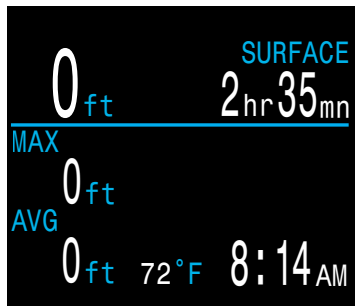

Gauge - Surface Display



Gauge - Dive Display

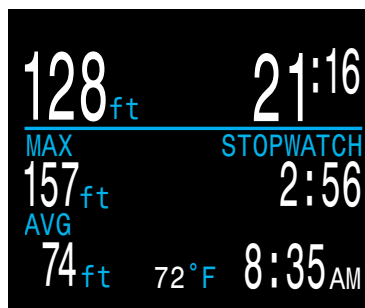

Stopwatch Running

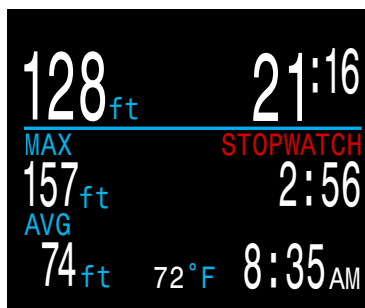

Stopwatch Stopped

Features:

- Extra-Large Depth Display (in feet or meters)
- Extra-Large Time Display (in minutes:seconds)
- Maximum and Average Depth on main screen.
- Stopwatch
- Resettable Average Depth

The Gauge display is organized as:

- Depths along the left.
- Times along the right.
- Most important information (Depth, Dive Time) on the top row.

Stopwatch

When diving, starting or stopping the Stopwatch is the first menu option.

When stopped, the word “Stopwatch” displays in red.

When non-zero, the stopwatch can be reset. Reset behavior depends on state:

- If running when reset, it continues running, counting up again from 0.
- If stopped when reset, then it is set 0 and remains stopped.

Resettable Average Depth

During a dive, the average depth can be reset.

While on the surface, the MAX and AVG values display the maximum and average depth of the last dive. The AVG depth displayed on the surface is for the entire dive, regardless of whether the reset average depth option was used. The dive log also records the average depth for the entire dive.

DECOMPRESSION AND GRADIENT FACTORS

The basic decompression algorithm used for the computer is Bühlmann ZHL-16C. It has been modified by the use of Gradient Factors that were developed by Erik Baker. We have used his ideas to create our own code to implement it. We would like to give credit to Erik for his work in education about decompression algorithms, but he is in no way responsible for the code we have written.

The computer implements Gradient Factors by using levels of conservatism. The levels of conservatism are pairs of number like 30/70. For a more detailed explanation of their meaning, please refer to Erik Baker's excellent articles: **Clearing Up The Confusion About "Deep Stops"** and **Understanding M-values**. The articles are readily available on the web. You might also want to search for "Gradient Factors" on the web.

The default of the system is 30/70. The system provides several settings that are more aggressive than the default.

Don't use the system until you understand how it works.

Graph from Erik Baker's "Clearing Up The Confusion About Deep Stops"

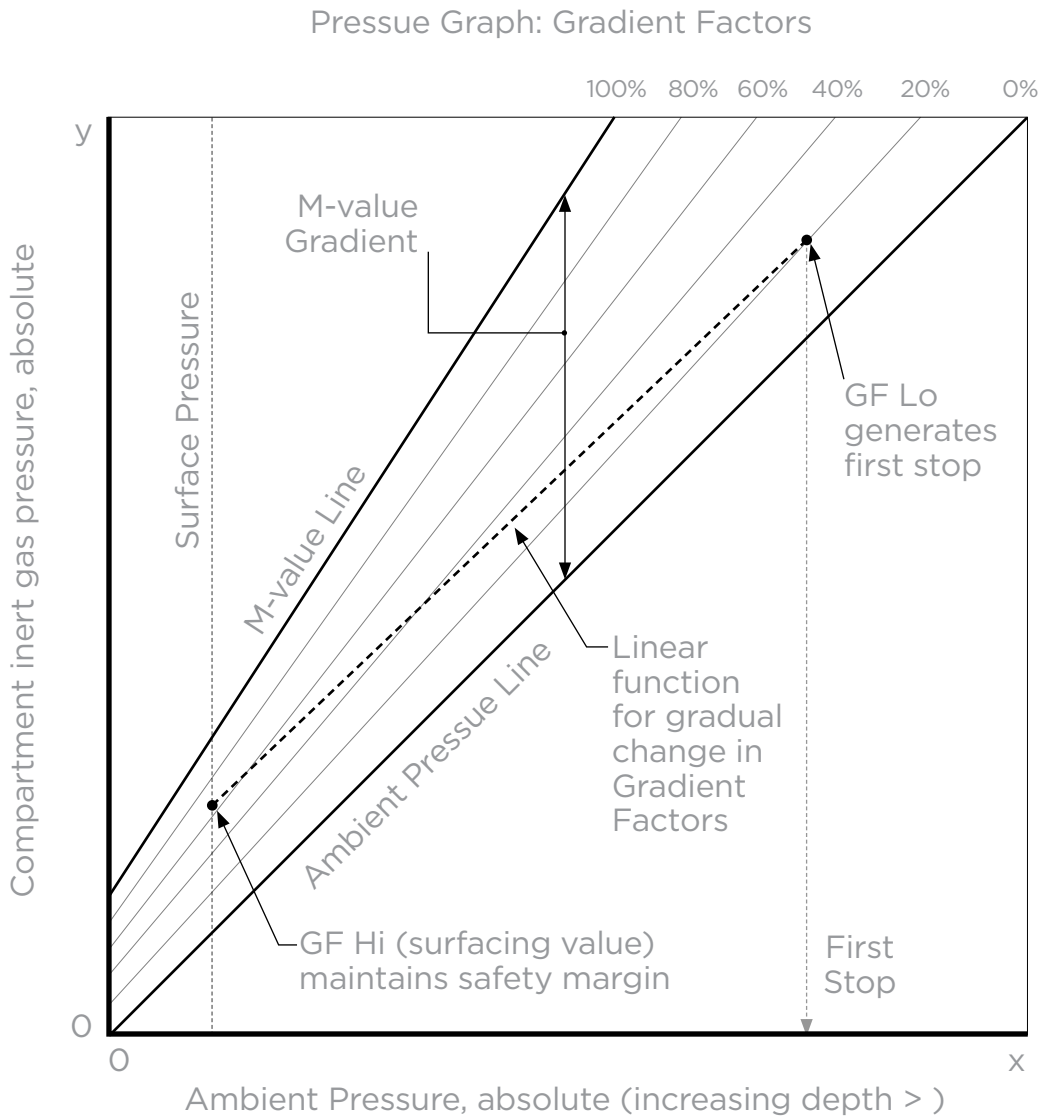

- A Gradient Factor is simply a decimal fraction (or percentage) of the M-value Gradient.
- Gradient Factors (GF) are defined from 0% to 100%.
- A Gradient Factor of 0% represents the ambient pressure line.
- A Gradient Factor of 100% represents the M-value line.
- Gradient Factors modify the original M-value equations for conservatism within the decompression zone.
- The lower Gradient Factor value (GF Lo) determines the depth of the first stop. Used to generate deep stops to the depth of the "deepest possible deco stop"

MENU REFERENCE



Turn Off

The “Turn Off” item puts the computer to sleep. While sleeping, the screen is blank, but the tissue contents are maintained for repetitive diving. The “Turn Off” menu item will not appear during a dive on any model. It will also not appear after a dive until the End Dive Delay Time has expired to allow for a continuation dive.

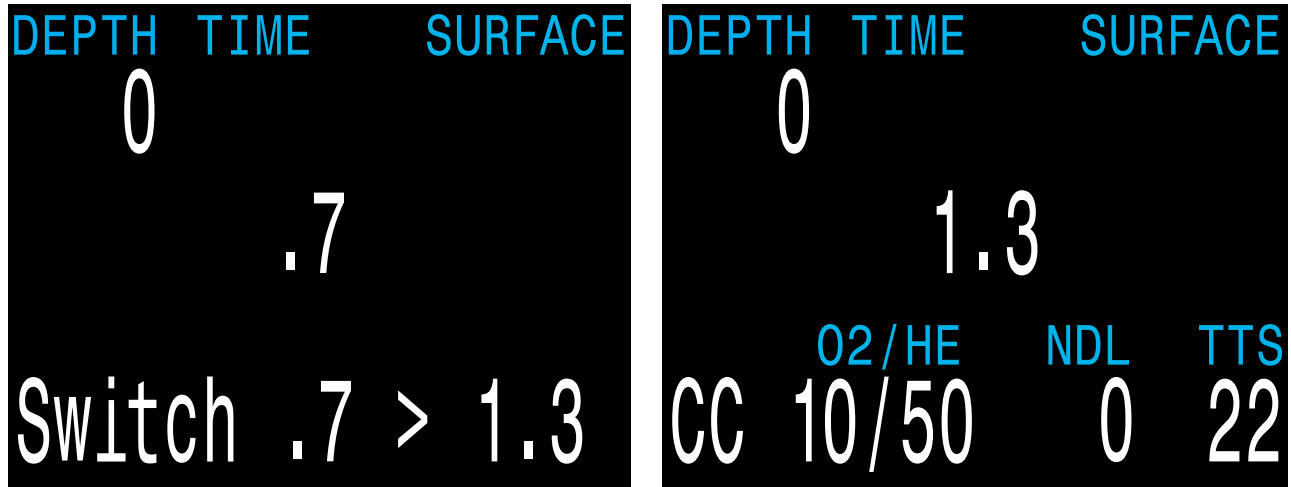

Switch Setpoint

This menu is only available in CC mode.

The internal PPO2 mode is used to calculate decompression for a unconnected rebreather. In this case, the setpoints are switched in the computer to approximate the rebreather setpoint.

During a dive the “Switch Setpoint” menu item will be the first item displayed, since the “Turn Off” displays are disabled when diving.

Pressing SELECT when this menu is displayed changes the PPO2 setpoint from the low setpoint to the high setpoint or vice-versa. To redefine the PPO2 value of a setpoint, use the Dive Setup menu.

This menu item performs a manual switching of PPO2 setpoint. In the [System Setup](#) → [Auto SP Switch](#) menu, the Perdix can be setup to automatically perform setpoint switches at programmable depths. When auto setpoint switches are enabled, this menu item is still available to provide manual control.

Select Gas

This menu item allows you to pick a gas from the gases you have created. The selected gas will be used either as the breathing gas in open circuit mode, or the diluent in closed circuit mode.

Gases are always sorted from most to least oxygen content.

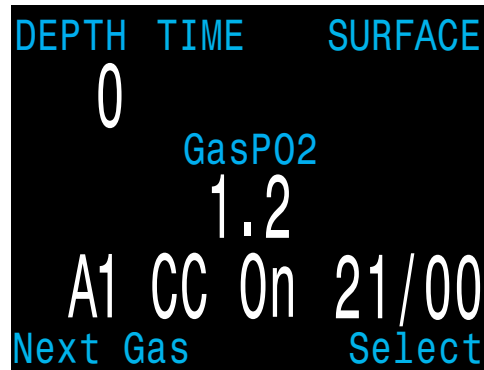
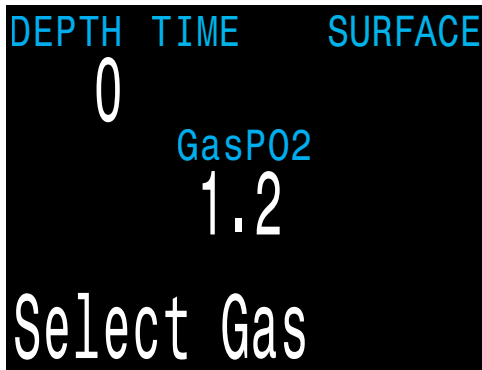

Use the MENU button to increment to the desired diluent/gas, then press the SELECT button to select that diluent/gas.

If you increment past the number of gases available, the display will fall back out of the “Select Gas” display without changing the selected gas.

An ‘A’ will appear next to the currently active gas.

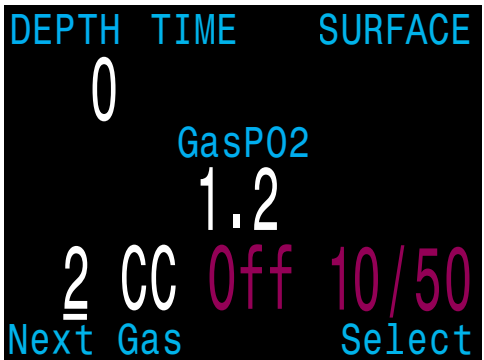
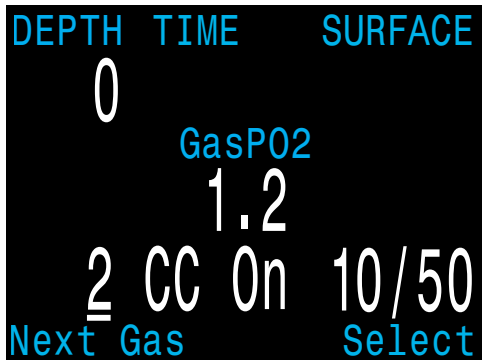

A gas that is off will be shown in **Magenta**, but can still be selected. It will be turned on automatically if it is selected. Off gases are not used in decompression calculations.

Watch the video:
[New Gas Select Style](#)



Radio Station Gases

For computer models that support open circuit and closed circuit operation, the system maintains two sets of gases - one for open circuit and one for closed circuit.

The way they operate is very similar to the way car radios work with AM and FM stations.

When you are listening to an FM station and you push a station selection button, it will take you to another FM station. If you add a new station, it will be an FM station.

Similarly, if you are in the AM mode, adding or deleting a station would add or delete an AM station.

With radio station gases, when you are in open circuit, adding, deleting or selecting a gas will refer to an open circuit gas. Just like the FM stations are selected when your radio is in FM mode, the closed circuit gases are available in the closed circuit mode. When you switch to open circuit, the gases available will be open circuit gases.

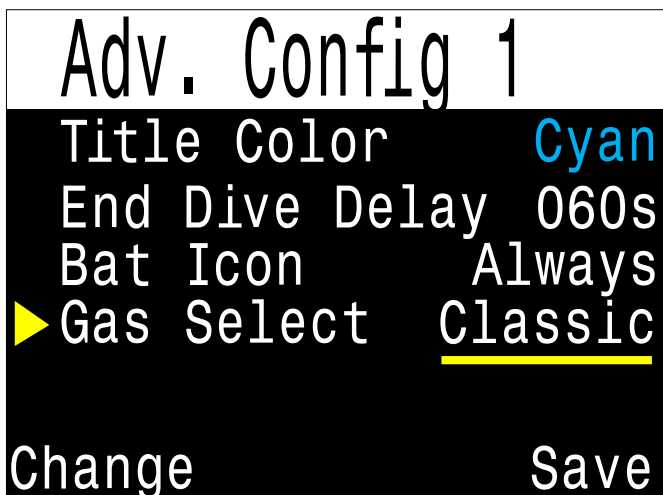

Classic Select Gas

Select Gas Menu Styles

Two styles of Select Gas menus are available, Classic and New.

Change between the two styles in the Adv. Config 1 menu.

Classic Style Select Gas

- The classic Select Gas style is as described on the previous page.
- One gas is shown at a time.
- Press MENU to step through gases, and SELECT to select the shown gas.
- Gases are sorted from highest O2% to lowest O2%.
- Stepping past the last gas will exit the menu without changing the active gas.
- Upon entering the Select Gas menu, the first gas shown is always the highest O2% gas.

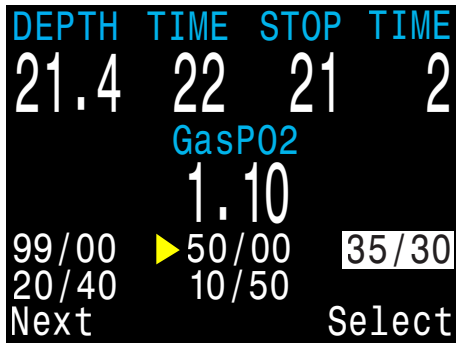

New Style Select Gas



Off Gases are Magenta

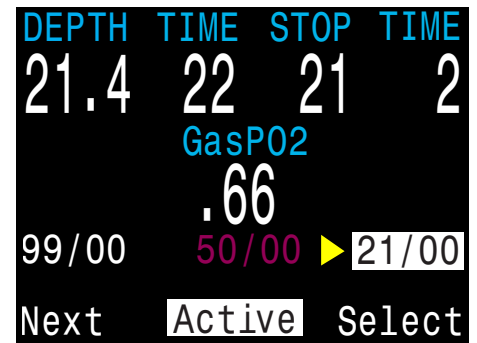

Active Gas is White

New Style Select Gas

The new style makes visualizing the gas list easier. It also reduces button presses for deco gas switches.

- Shows all gases on the screen at once.
- Press MENU to step through gases, and SELECT to select the pointed to gas.
- A gas must be selected to exit the menu (scrolling past last gas wraps back to first gas).
- The active gas is shown with a white background.
- Turned off gases are shown in **Magenta** (purple).
- Gases are sorted from highest O2% to lowest O2%.
- When diving and there is a deco stop, the first gas pointed to will be the most appropriate gas (highest PPO2 less than 1.61). This reduces button presses in most cases.
- On the surface or when no deco stops are needed, the first gas pointed to will be the active gas.

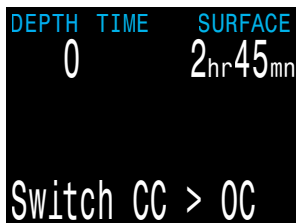

Switch to OC/CC

Depending on the current computer setting, this selection will show as either “Switch CC > OC” or “Switch OC > CC”.

Pressing SELECT will select the displayed mode for decompression calculations. When switching to open circuit while diving, the most appropriate open circuit gas will become the breathing gas for calculations.

At this point, the diver may want to switch to a different gas, but since the diver may have other things to deal with, the computer will make a “best guess” of which gas the diver would choose.

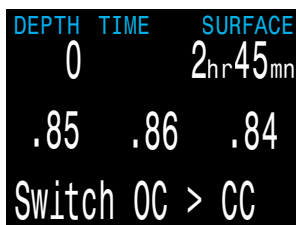

You can also switch to from CC to OC on a fixed PPO2 model. In that case, the computer will use the user entered high and low setpoints.

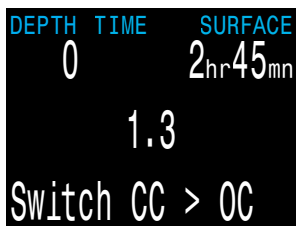

Awaiting this section which is being re-written.

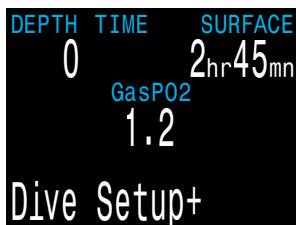

Dive Setup+

The Dive Setup menus are available both on the surface and when diving.

The values in Dive Setup+ can also be accessed in the Systems Setup+ menu, but the System Setup+ menu is not available when diving.

Pressing SELECT will enter the Dive Setup sub-menu.

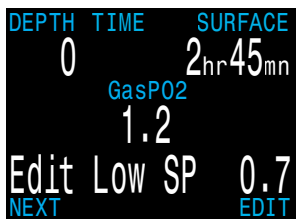

Low Setpoint OC/CC ONLY

This item allows you to set the low setpoint value. It will display the currently selected value. Values from 0.4 to 1.5 are allowed. A press of MENU will increment the setpoint.



Press the SELECT button w Awaiting this section which is being re-written.
display will be shown. It is set at the lowest valid value for setpoint, .4.

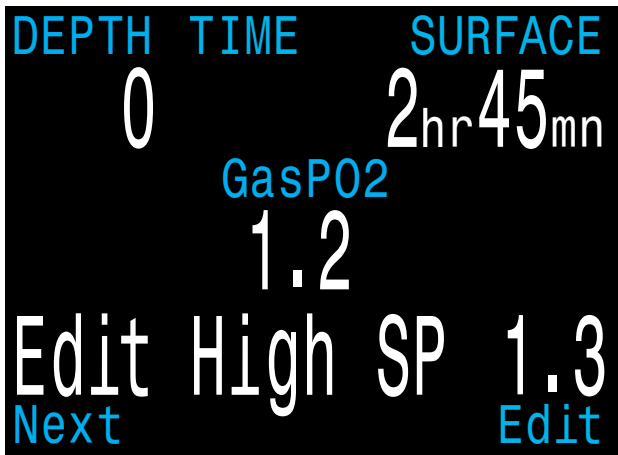

Another press of MENU will increment it again.

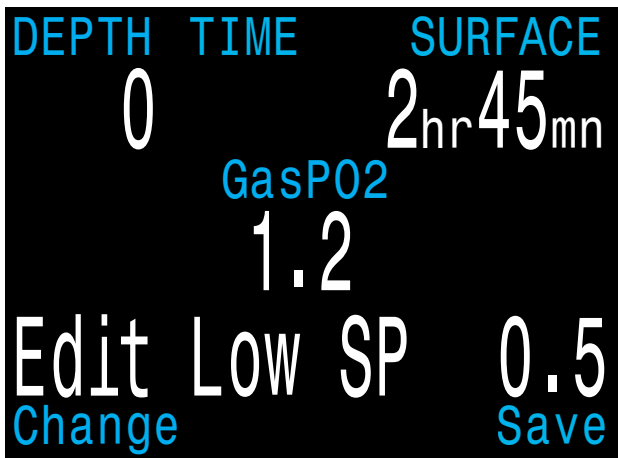

If SELECT is pushed, the currently displayed setpoint will be selected, and the display will return to the “Edit Low SP” menu item.

If the highest allowable value, 1.5, has been passed, the value will return to 0.4.

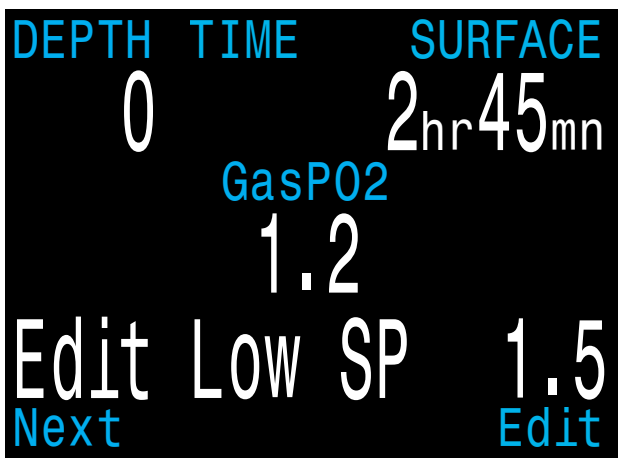

High Setpoint

The high setpoint function works exactly like the low setpoint function.

Define Gas

The function allows you to set up 5 gases in Closed Circuit and 5 gases in Open Circuit. You must be in Open Circuit to edit open circuit gases, and you must be in Closed Circuit to edit closed circuit diluents. For each gas, you can select the percentage of oxygen and helium in the gas. The remainder is assumed to be nitrogen.



Pushing SELECT when “Define Gas” is displayed presents the function to define gas number 1.

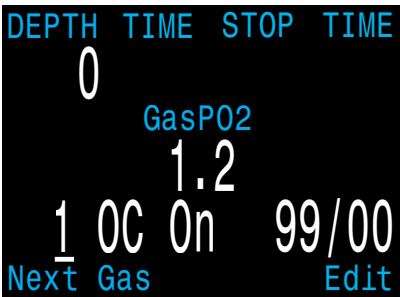

Pushing the MENU button will display the next gas.

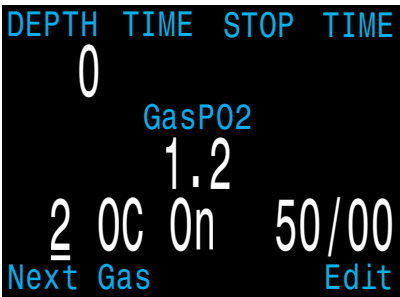

Pushing SELECT will allow you to edit the current gas. The gas contents are edited one digit at a time. The underline will show you the digit being edited.

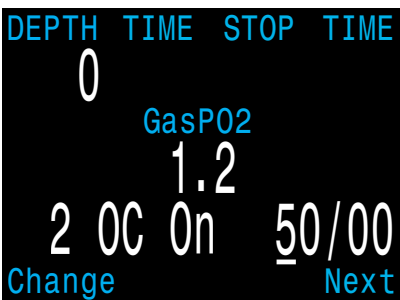

Each push of the MENU button will increment the digit being edited. When the digit reaches 9, it will roll over to 0.

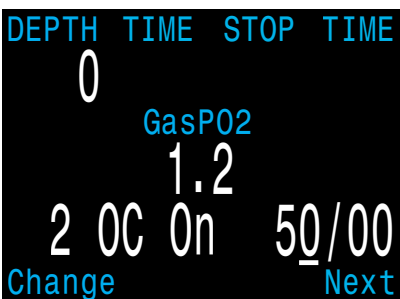

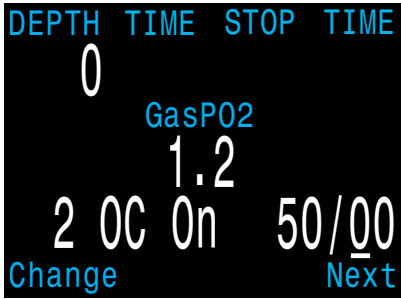

Pushing SELECT will lock in the current digit, and move on to the next digit.

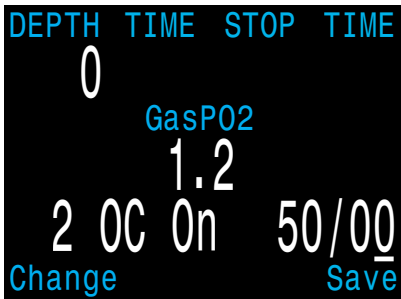

Pushing SELECT on the last digit will finish editing that gas, and bring you back to the gas number.

Any gases that have both oxygen and helium set to 00 will not be displayed in the “Select Gas” function.

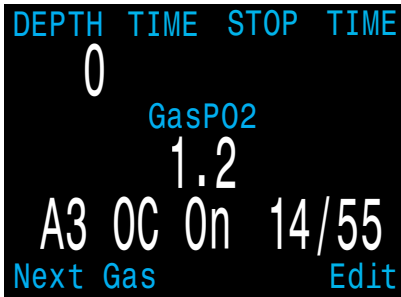

Pushing MENU will continue to increment the gas number.

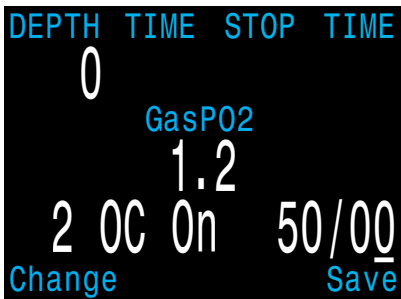

Note: The “A” denotes the active gas. You cannot delete the active gas. If you try, it will generate an error. You can edit it, but cannot set both the O2 and HE to 00.

The computer will display all 5 gas entries available to allow you to enter new gases.

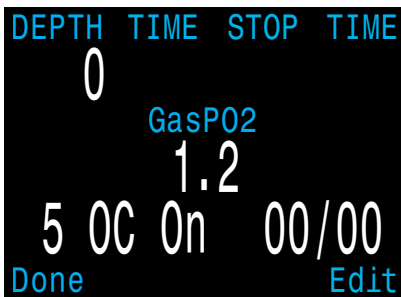

Pressing MENU one more time when the fifth gas is displayed will return you to the “Define Gas” menu item.



WARNING

ONLY TURN-ON GASES YOU ARE CARRYING

Only turn on the gases you are actually carrying on the dive. With radio station gases, the computer has a full picture of the OC and CC gases you are carrying and can make informed predictions about decompression times. There is no need to turn gases off and on when you switch from CC to OC, because the computer already knows what the gas sets are. You should have the CC and OC gases you are actually carrying turned on.

If you often use other gases, but not on this dive, you can enter the gas and turn it off. You can turn gases on and off during a dive and you can also add or remove a gas during the dive if needed.

DIVE PLANNER+

Introduction

- Calculates decompression profiles for simple dives.
- In closed-circuit (CC) mode, also calculates open-circuit (OC) bail-out (BO).

Setup

Uses the current gases programmed into the Perdix, as well as the current GF low/high settings. VPM-B dive planning is available on units with the optional VPM-B unlock. Deco profile is computed for the current circuit mode (CC or OC).

On the surface

Enter the dive bottom depth, bottom time, respiratory minute volume (RMV) and PPO2 (closed-circuit only).

Note: Residual tissue loading (and CNS%) from recent dives will be used in calculating the profile.

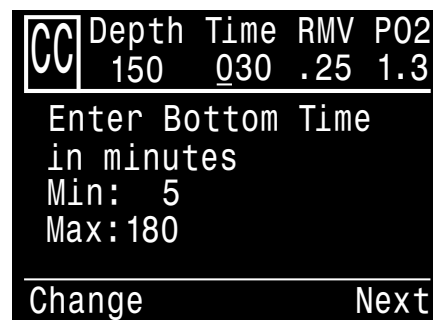

Dive Plan Setup

During a dive

Computes the decompression profile assuming the ascent will begin immediately. There are no settings to enter. (RMV is last used value)

Limitations

The Perdix Dive Planner is intended for simple dives. Multi-level dives are not supported.

The Perdix Dive Planner makes the following assumptions:

- Descent rate is 60ft/min (18m/min) and the ascent rate is 33ft/min (10m/min).
- For OC, the gas in use will be the gas with the highest PPO2 less than 1.40 for the bottom gas, and 1.61 for deco gases (the deco gas max PPO2 can be changed in the Adv Config 1 menu).
- For CC, the gas in use will be the gas with the highest PPO2 less than 1.05.
- The planner will use the configured last stop depth.
- For CC, the PPO2 is constant for the entire dive.
- The RMV is the same while diving as during deco.

The Dive Planner does not provide thorough validation of the profile. For example, it does not check for nitrogen narcosis limitations, gas usage limitations, CNS percentage violations, or isobaric counter-diffusion risks due to sudden helium switches. The user is responsible for ensuring a safe profile is followed.

Result screens

The results are given in tables showing:

- Stp: Stop Depth In feet (or meters)
- Tme: Stop Time In minutes
- Run: Run Time In minutes
- Qty: Gas Quantity in CuFt (or liters). OC and BO only

The first few rows will show the bottom time (bot) and the ascent legs (asc) to ascend to the first stop. Multiple ascent legs may be shown if gas switches are needed.

CC				
Depth	Time	RMV	P02	
150	030	.55	1.3	
Stp	Tme	Run	Gas	
150	bot	30	10/50	
70	asc	32	10/50	
70	1	33	10/50	
60	2	35	10/50	
50	1	36	10/50	
Quit			Next	

BO					
Depth	Time	RMV	P02		
150	030	.55	1.3		
Stp	Tme	Run	Gas	Qty	
30	5	43	36/00	6	
20	6	49	99/00	6	
10	11	60	99/00	8	
Quit			Next		

Example Results Table for Closed-Circuit and Bailout.

If more than 5 stops are needed, the results will be split onto on several screens. Use the right button to step through the screens.

For OC or BO profiles, a total gas consumption report is given.

BO				
Depth	Time	RMV	P02	
150	030	.55	1.3	
Gas Usage. In CuFt				
99/00:		14		
36/00:		14		
21/25:		7		
12/50:		0		
Quit			Next	

Gas Usage Report

The final result screen shows the total dive time, the time spent on deco and final CNS%.

```

CC Depth Time RMV P02
  150  030  .55  1.3
-----
CC Summary
Run:   61 minutes
Deco:  31 minutes
CNS:   34%
-----
Quit           Plan B0
    
```

Results Summary Screen

If no decompression is required, no table will be shown. Instead, the total No-Decompression-Limit (NDL) time in minutes, at the given bottom depth will be reported. Also, the gas quantity required to surface (bailout in CC) will be reported.

```

CC Depth Time RMV P02
  150  030  .55  1.3
-----
No Deco Stops.
Total NDL at 80ft
is 47 minutes
Bailout gas quantity
is 4 CuFt.
-----
Quit           Done
    
```

No Decompression Results Screen

Conservatism

The conservatism settings (GF High and GF Low) can be edited in the Dive Setup menu. While diving, only the GH High value can be edited. This allows changing the surfacing conservatism during a dive. For example, if you worked much harder on the bottom segment than expected, you may wish to add conservatism by reducing the GF High setting

```

DEPTH TIME STOP TIME
  0
.85 .7 .84
Conserv 30/70
Next           Edit
    
```

NDL DISPLAY

The NDL Display option allows you to display four different values during the dive. The display can be changed during the dive to provide different information. The value selected here replaces the NDL on the main screen once decompression stops are required.

- 1 NDL
- 2 CEIL
- 3 Buhlmann
- 4 @+5

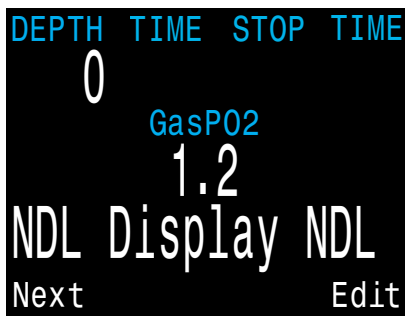

1 Pushing SELECT will make the NDL display editable. The first choice available will be **NDL**. If you select NDL, the NDL will always be displayed during the dive whether or not you have a decompression ceiling.

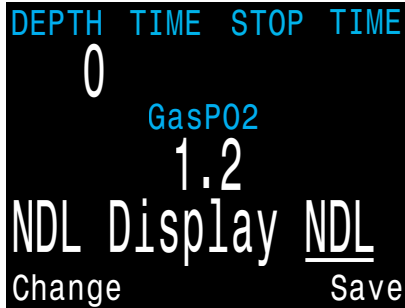

2 The next selection is **CEIL**. With this setting, as long as the NDL time is 0 (you have a decompression ceiling), the raw ceiling will be displayed instead of the NDL. This is the equivalent of the 'Man on a rope'. It will show your ceiling without it being rounded up to the next even 10 foot or 3 meter stop. Please note that there is very limited information on the effects of following a continuous ceiling instead of stopping at stops and only moving up to the next stop when the stop has cleared.

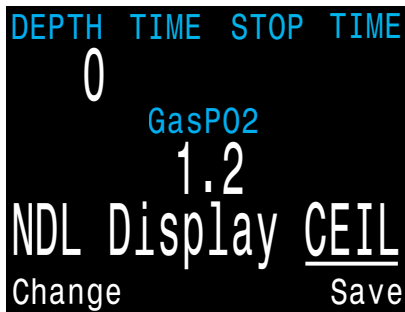

It is the Shearwater's opinion that all stops should be honored. It seems intuitive that if you have bubbles, and you stop, you give the bubbles an opportunity to be resorbed. If you continuously ascend, the ambient pressure is continuously reduced which prevents bubbles from shrinking. Because of this belief, the computer will give one **MISSED DECO STOP** message during the dive and one after the dive, and will flash the stop depth and time in **red** as long as you are above the stop depth. It will use the increased gradient though, and your calculated off-gassing will be faster than staying at the stops.

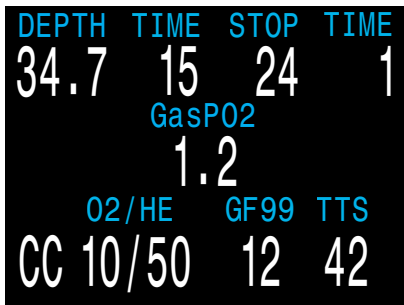
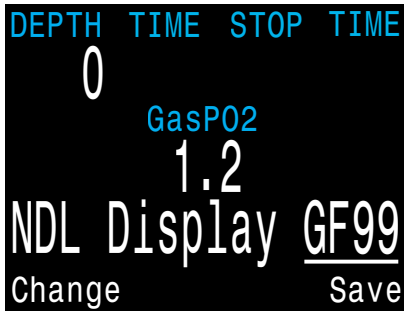

- 3 The next option is to display the actual supersaturation gradient for a pure Bühlmann (99/99) profile.

The selection is **GF99**. With this setting, as long as the NDL time is 0 (you have a decompression ceiling), the gradient will be displayed instead of the NDL.

The number shown is the percentage of supersaturation. The number is calculated by reference to the Ambient Pressure Line and the M-Value line. It can be thought of as the current GF, but it is different in a couple of ways. First, the current GF generates stops rounded to the nearest 10 feet or 3 meters. So a gradient of 40 may reflect a ceiling of 15 feet, but the computer will show a rounded-up 20 foot stop.

This number can be used in several ways. First, it can be used to calculate an aggressive ascent that still has some justification in decompression science. For example, if a diver were to lose a significant portion of their gas and needed to get shallow fast, they could ascend until they reached a gradient of 90, then stop until it dropped to 80, then ascend to 90 again, etc. That would produce a Bühlmann-like profile with very little conservatism. In an emergency, that may be an acceptable risk.

Another use might be to do a slower ascent on a dive to sightsee, but to stay in the decompression zone by keeping the gradient above 0.

Another use would be to observe the rapidly increasing gradient in the last 10 feet to the surface and slow that ascent.

All of this is based on gradient theory that may be completely false. There is significant disagreement in the decompression research community about the nature and practice of decompression. Any techniques described here should be considered experimental, but the concepts may be useful to the advanced diver.

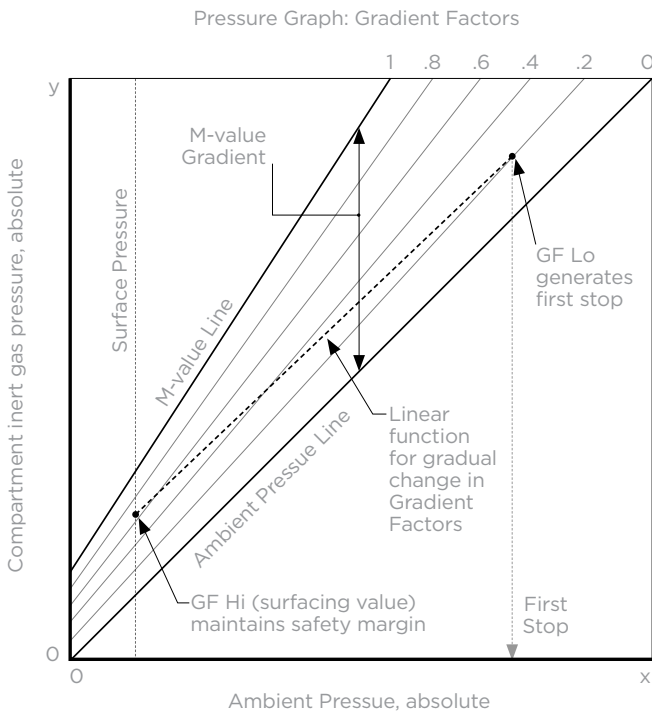

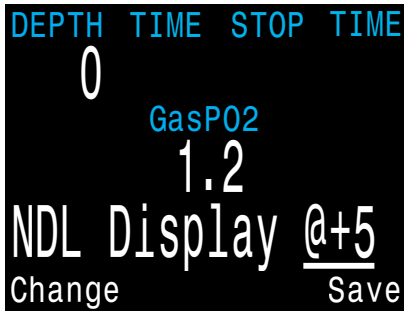

- ④ The last selection is **@+5**. This feature was inspired by Dan Wible’s CCR2000 computer (Thanks Dan!) It is the time-to-surface (TTS) if you were to stay at the current depth for five more minutes. This can be used as a measure of how much you are on-gassing or off-gassing.

For example, on a dive on a wreck, you go to the bottom until you accumulate the desired decompression and TTS. After ascending to the second deck, you notice that the @+5 and TTS are the same. That means that you can spend 5 minutes exploring this deck without incurring more decompression.

Once you get to the top deck, the current has picked up. The line runs from the top of the deck to the surface which is a distance of 30 feet/10 m. You see that your @+5 is 11 minutes and your TTS is 15 minutes. That means that you can stay down out of the current for 5 minutes and burn off about 4 minutes of deco. You may decide to accept the 80% decompression efficiency and stay out of the current.

When your TTS is 10 minutes, you see that your @+5 is 9 minutes. Since the decompression is not very efficient now, you go up the line and spend the last 10 minutes in the current.

BRIGHTNESS



The display brightness has three fixed brightness settings plus an Auto mode.

The fixed options are:

- 🔵 **Low:** Second longest battery life.
- 🔵 **Med:** Best mix of battery life and readability.
- 🔵 **High:** Easiest readability, especially in bright sunlight.

Auto will use the light sensor to determine the brightness of the display. The more ambient light there is, the brighter the display will get. At depth, or in dark water, very little brightness is needed to see the display.

The Auto setting works well in most situations.

The brightness of the display is the major determinant of battery life. Up to 80% of the power consumption is to power the display. When a low battery alert occurs, the display brightness is automatically reduced to extend battery life.

DIVE LOG MENU

Watch the video:
[Dive Log](#)



Display Log

At the “Display Log” prompt, press SELECT to view the most recent dive.

The profile of the dive is plotted in blue, with decompression stops plotted in red. The following information is displayed:



- Maximum and Average depth
- Dive number
- Date (dd/mon/yyyy)
- Start - Time of day dive started
- End - Time of day dive ended
- Length of dive in minutes

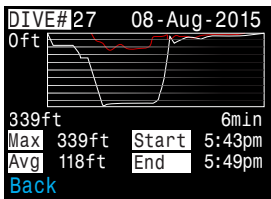

Press MENU to see the next dive, or SELECT to quit viewing logs. Press Back to see the list of dive logs, and next to select the next dive and View.



Upload Log

See “[Dive Log Download](#)” instructions.

Logs are uploaded using Bluetooth. Selecting this menu item starts the Bluetooth connection and then waits for commands from a desktop or laptop computer.



Edit Log Number

The dive log number can be edited. This is useful if you want the Perdix log numbers to match your lifetime dive count.

At the “Edit Log Number” prompt, press SELECT to begin editing. While editing, use MENU to change the value of the currently underlined digit, and SELECT to move to the next digit.

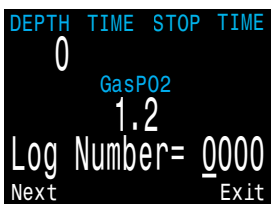

The next dive number will be +1 from the value entered here. For example, if you enter 0015, then the next dive will be dive number 16.



IMPORTANT INFORMATION FOR OPEN CIRCUIT DIVERS

All Perdix models include Closed Circuit (CC) functionality.

Leaving CC mode enabled makes the Perdix more complex and less optimized for OC diving.

Switch Mode from OC/CC to OC Tec or OC Rec before performing an open circuit only dive.

Also, when CC mode is available, then OC is treated as bailout. This is why OC is shown as a yellow warning when CC mode is available.

SYSTEM SETUP+

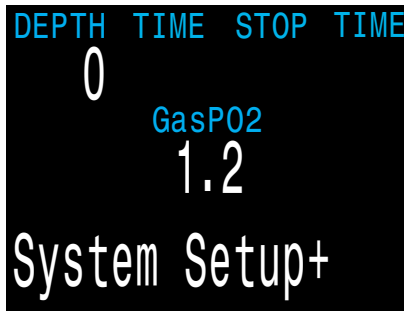

System Setup contains configuration settings together in a convenient format for updating the configuration before a dive.

System setup cannot be accessed during a dive.

However, many of the settings are also available during the dive in a single line interface. Although all of the settings available in Dive Setup are available in System Setup, not all settings in System Setup can be edited in Dive Setup.

The MENU and SELECT buttons are context sensitive to each sub menu and individual setting.

Example Menu	
▶ Example	0.00
Example	0.00
Example	0.00
Example	0.00
Example	0.00
Next	Edit

Example Menu	
▶ Example	<u>0</u> .00
Example	0.00
Example	0.00
Example	0.00
Example	0.00
Change	Next

When cycling through the sub-menus, MENU will carry the user to the next sub-menu, while SELECT will allow the user to edit the options in this submenu.

Once the user has pressed SELECT to edit a submenu, MENU will cycle the user through the different submenu listings, while SELECT will let the user edit those listings.

Once the user has pressed SELECT to edit a submenu listing MENU will be used to change the context sensitive variable, while the SELECT button will be used to move to the next field. Once the user has pressed SELECT through all the fields, the new user preferences will be saved.

MODE SETUP

The first submenu of System Setup+ is Mode Setup.

Mode Setup	
Mode	OC/CC
Salinity	Fresh
PP02 Mode	Int.
Low SP	0.7
High SP	1.3
Next	Edit

Mode

Mode sets which breathing circuit configurations are available:

- OC/CC (default)
- OC Tec
- OC Rec
- Gauge (e.g. bottom timer mode)

When changing to or from Gauge mode, the decompression tissues are cleared. This is because when in Gauge mode the Perdix does not know what gas you are breathing, , and therefore cannot track inert gas loading.

Salinity

Water type (salinity) affects how the measured pressure is converted to depth. Settings:

- Fresh
- EN13319
- Salt

Freshwater and Saltwater differ by about 3%. Saltwater, being denser, will display a shallower depth for the same measured pressure versus the Fresh setting.

The EN13319 value is between Fresh and Salt. It is from the European CE standard for dive computers, and is the Perdix's default value.

PPO2 Mode

▶ Mode Setup	
Mode	OC/CC
Salinity	Salt
PPO2 Mode	Int.
Low SP	0.7
High SP	1.3
Next	Edit

PPO2 mode is only set when CC is enabled.

On the Perdix this value is always Int (internal fixed PPO2).

Low and High Setpoints

The Low and High PPO2 Setpoints are only available when CC is enabled.

Each setpoint can be set from 0.4 to 1.5.

The setpoints can also be edited, even during a dive, in the Dive Setup menu.

DECO SETUP

Deco Setup	
Deco Model	GF
Conserv (GF)	30/70
Last Stop	6m
NDL Display	CEIL
Next	Edit

Deco Model

May just show Bühlmann ZHL-16 with gradient factors model, or it may allow you to switch between GF and various types of VPM-B. The choices will be available if you have unlocked VPM-B.

Conservatism

Can be adjusted in either the GF or VPM model. For a more detailed explanation of their meaning for the GF algorithm, please refer to Erik Baker’s excellent articles: **Clearing Up The Confusion About “Deep Stops”** and **Understanding M-values**. The articles are readily available on the web. VPM-B has conservatism settings from 0 to +5, with higher numbers being more conservative.

Last Stop

Allows you to choose where to do your last stop. The choices are 10ft/3m and 20ft/6m. Note that this setting does not affect decompression. It only makes the TTS prediction more accurate.

NDL Display

These options were previously covered in the Dive Setup+ section.

OC Gases		
1 OC	On	21/00
2 OC	Off	00/00
3 OC	Off	00/00
4 OC	Off	00/00
5 OC	Off	00/00
Next	Edit	

OC Gases

The next submenu is OC Gases. This menu allows the user to edit the open circuit gases. The options contained here are the same as those in the “Define Gases” subsection of the “Dive Setup” section contained earlier in this manual. This menu page conveniently displays all five gases simultaneously.

For a description of how to appropriately set each gas, please see the earlier Define Gas section

CC Gases		
A1 CC	On	21/00
2 CC	Off	00/00
3 CC	Off	00/00
4 CC	Off	00/00
5 CC	Off	00/00
Next	Edit	

CC Gases

The next submenu is CC Gases. This menu allows the user to edit the closed circuit diluent gases. The options contained here are the same as those in the “Define Gases” subsection of the “Dive Setup” section contained earlier in this manual. This menu page conveniently displays all five gases simultaneously.

For a description of how to appropriately set each gas, please see the earlier Define Gas section.

Auto SP Switch		
Up:	0.7>1.3	Auto
Up Depth		070ft
Down:	1.3>0.7	Auto
Down Depth		040ft
Next		Edit

Auto SP (Setpoint) Switch

This menu page is only available in CC mode when PPO2 mode is set to internal (see Dive Setup page).

Auto Setpoint Switch configuration sets up the setpoint switching. It can be set up to auto switch up only, down only, both, or neither.

First, you set whether the “Up” switch occurs automatically or manually. If “Up” is set to “Auto”, then you can set the depth at which the auto switch occurs.

The menu options are the same for the down setpoint switch.

Example:

Up: 0.7 > 1.3 = Auto, Up Depth = 70 ft.
 Down: 1.3 > 0.7 = Auto, Down Depth = 41ft

The dives starts at the 0.7 setpoint. As you descend past 70ft, the setpoint switches “up” to 1.3.

You finish your bottom time, then begin ascending. When you ascend above 41ft, it switches “down” to 0.7.

When a switch is set to “Auto”, you can always manually override the setting at any time during the dive.

The automatic switches only occur when crossing the specified depth. Say for example, the switch up depth is set to 50ft. You start the dive on the low setpoint, then as you descend past 50ft, the setpoint automatically switches up to high. If at say 80ft you then manually switch back to the low setpoint, the setpoint will remain low. If you ascend shallower than 50ft then re-descend deeper than 50ft again, the automatic setpoint switch will occur again. The Perdix enforces a 20ft (6m) gap between switch up and switch down depths to prevent rapid automatic switching between setpoints for small depth changes. The values 0.7 and 1.3 are shown as examples only. Other values for the low and high setpoint can be adjusted in the Dive Setup menu.

Auto SP Switch		
Up:	0.7>1.3	Auto
Up Depth		070ft
Down:	1.3>0.7	Auto
Down Depth		041ft
Change		Next

Auto SP Switch		
Up:	0.7>1.3	Auto
Up Depth		070ft
Down:	1.3>0.7	<u>Manual</u>
Change		Save

DISPLAY SETUP

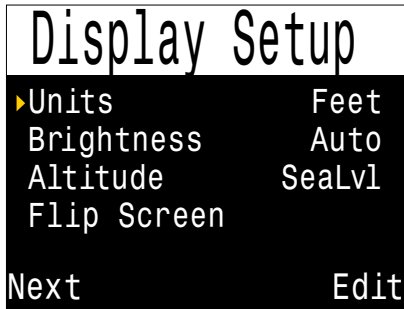

Units

Two options are available:

Feet: Imperial units (depth in feet, temperature in °F)

Meters: Metric units (depth in meters, temperature in °C)

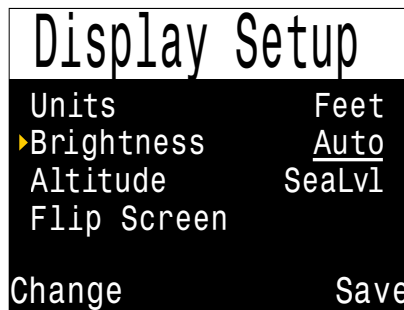
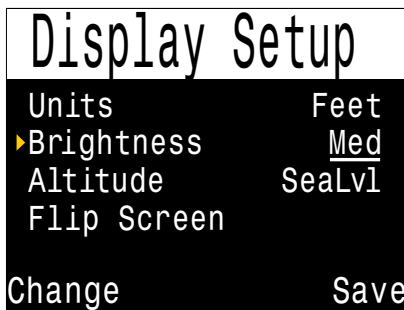

Brightness

Screen brightness can be set to fixed levels or an automatic setting.

Fixed options:

Cave: Made specifically for cave conditions. Longest battery life.

Low: Second longest battery life.

Med: Best mix of battery life and readability.

High: Easiest readability, especially in bright sunlight.

The “Auto” option measures ambient light levels and then adjusts the screen brightness to best performance. It provides maximum brightness in bright sunlight, but then lowers brightness to save battery life when the environment gets darker.

Altitude

The altitude setting when set to 'Auto' will compensate for pressure changes when diving at altitude. If all your diving is at sea level, then setting this to 'SeaLvl' will assume that surface pressure is always 1013 mBar (1 atmosphere).

Display Setup		Display Setup	
Units	Feet	Units	Feet
Brightness	Auto	Brightness	Auto
▶Altitude	<u>Auto</u>	▶Altitude	<u>SeaLvl</u>
Flip Screen		Flip Screen	
Change	Save	Change	Save

If the Perdix measures the surface pressure to be less than 965 mbar, then the Altitude setting will be forced to "Auto" and cannot be changed.



DETERMINATION OF SURFACE PRESSURE

Accurate depth measurements and decompression calculations require knowing the ambient atmospheric pressure at the surface. Regardless turn on method, the surface pressure is determined the same way. While in the off state the surface pressure is measured and saved every 15 seconds. A 10 minute history of these pressure samples is kept. Immediately after turn-on this history is examined and the minimum pressure is used as the surface pressure. The surface pressure is then remembered, and not updated again until the next turn-on.

Flip Screen

This function displays the contents of the screen upside down.

The Flip Screen is of limited use on the Perdix model, but can be used if you wish to wear the Perdix such that the buttons are on the top of the device.



In the normal orientation, buttons are at the bottom of the display. If you flip the display, the buttons will be up top when the Perdix is worn on the wrist.

COMPASS SETUP

Compass	
▶ Compass View	90°
Calibrate	
True North	+0°
Next	Edit

Compass View

The Compass View setting can be set to:

- Off: The compass is disabled.
- 60°, 90°, or 120°: Sets the range of the compass dial that is visible on the main screen. The actual amount of arc that there is room for on the screen is 60°, so this may feel the most natural. The 90° and 120° settings allow a wider range to be seen at once. The default is 90°.

Compass	
Compass View	90°
Calibrate	
▶ True North	+0°
Next	Edit

True North

In most places, a compass does not point towards True North, but rather to Magnetic North. The difference in angle between these two directions is called the magnetic declination (also called magnetic variation), and varies around the world. The declination in your location can be found on maps or by searching online.

This setting can be set from -99° to +99°.

If you only need to match an uncompensated compass, or your navigation is all based on relative directions, then this setting is not necessary and can be left at 0°.

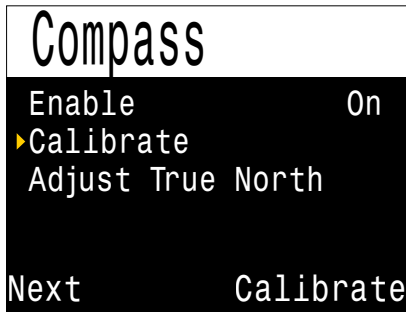

Calibrate

Calibration of the compass may be needed if the accuracy drifts over time or if a permanent magnet or ferromagnetic metal (e.g. iron or nickel) object is mounted very close to the Perdix. To be calibrated out, such an object must be mounted with the Perdix so that it moves along with the Perdix.



BATTERY AFFECTS THE COMPASS CALIBRATION

Each battery has its own magnetic signature, mostly due to its steel case. Therefore, recalibrating the compass when changing the battery is recommended.

Compare the Perdix with a known good compass or fixed references to determine if calibration is needed. If comparing against fixed references, remember to consider the local deviation between Magnetic North and True North (declination).

Calibration is typically not needed when travelling to different locations. The adjustment needed then is the True North (declination).

When calibrating, rotate the Perdix smoothly through as many 3D twists and turns as possible in 15 seconds. Keep metal and magnetic objects away during calibration. The calibration can also be reset back to the factory values. After calibration, it is recommended to compare the compass accuracy with a known good compass or fixed references



TIPS FOR A GOOD COMPASS CALIBRATION

- Stay away from metal objects. For example, wrist watches, metal desks, boat decks, desktop computers, etc. can all interfere with the Earth’s magnetic field.
- Rotate to as many 3D positions as possible. Upside down, sideways, on edge, etc.
- Compare with another compass (not a smartphone as those are terrible) to check your calibration.

SYSTEM SETUP

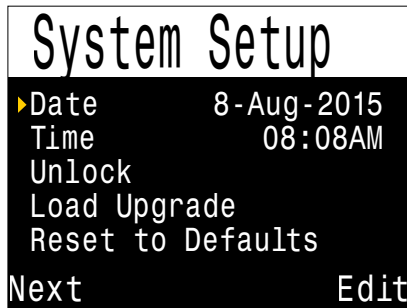

Date

The first 'System Setup' changeable option is 'Date,' which allows the user to set the current date.

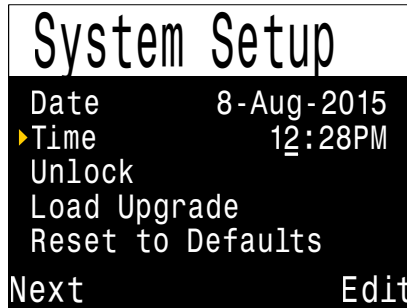

Time

The next 'System Setup' changeable option is 'Time', which allows the user to set the current time. The format can be set to AM, PM or 24 hour time

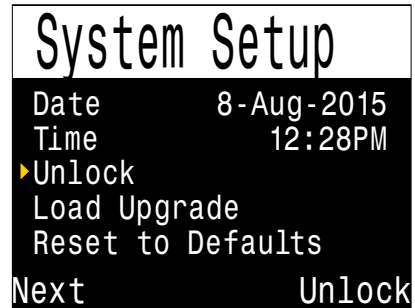

Unlock Code

The next 'System Setup' changeable option is 'Unlock' which allows the user the VPM-B Unlock in a code in order to add a 2nd decompression algorithm

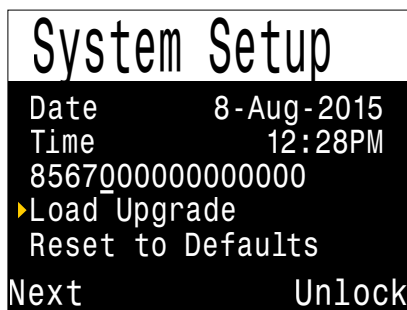

Load Upgrade

Use this option to load firmware upgrades. This starts a Bluetooth connection and then waits for commands from a laptop or desktop computer.



See the section ['Firmware Upload and Dive Log Download'](#) for detailed instructions

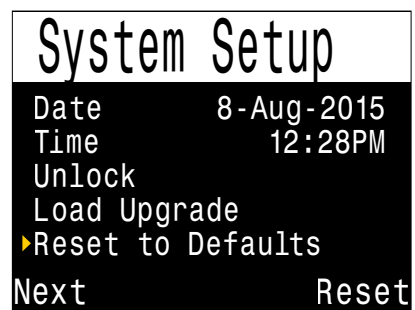

Reset to Defaults

The final 'System Setup' option is 'Reset to Defaults'. This will reset all user changed options to factory settings and clear the tissues on the Perdix. 'Reset to Defaults' cannot be reversed.

Note: This will not delete dive logs, or reset dive log numbers.

ADVANCED CONFIGURATION 1

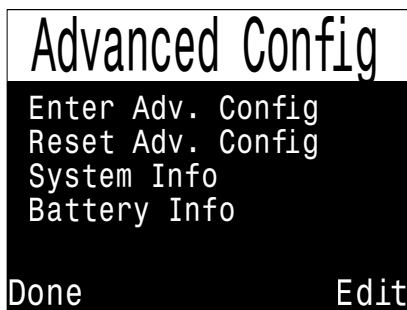

Advanced configuration contains items that will be used infrequently and can be ignored by most users. They provide more detailed configurations.

The first screen allows you to enter the advanced configuration area, or to set the advanced configurations settings to their default.

Title Colour

The title colors can be changed for added contrast or visual appeal. Default is Cyan, with gray, white and blue also available.

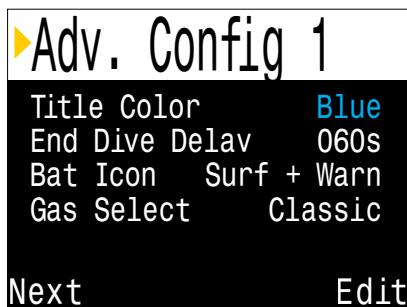

Main Colour

Main colours can also be changed for added contrast. Default is white but can be changed to green.

End Dive Delay

Sets the time in seconds to wait after surfacing before ending the current dive.

This value can be set from 20 seconds to 600 seconds (10 minutes). Default is 60s.

This value can be set to a longer time if you want brief surface intervals connected together into one dive. Some instructors use a longer end dive delay when teaching courses. Alternatively, a shorter time can be used to exit dive mode more quickly upon surfacing.

Battery Icon

The behavior of the battery icon can be changed here. Options are:

Surf+Warn: The battery icon always displays when on the surface. During dive it displays only if there is a low battery warning.

Always: The battery icon always displays.

Warn Only: The battery icon only appears when there is a low battery warning (this is how the Predator operates).

Gas Select

The style of Select Gas menu. Either Classic or New. Classic style shows one gas at a time in the large font. New style shows all gases at once, but in the small font.

ADVANCED CONFIGURATION 2

This section allows changing of PPO2 limits.



WARNING

Do not change these values unless you understand the effect.

▶ Adv. Config 2		
OC Min.	PPO2	0.19
OC Max.	PPO2	1.65
OC Deco	PPO2	1.61
CC Min.	PPO2	0.40
CC Max.	PPO2	1.60
Done		Edit

All values are in absolute atmospheres [ata] of pressure (1 ata = 1.013 Bar)

OC Min. PPO2

PPO2 displays in flashing red when less than this value. (Default 0.19)

OC Max. PPO2

PPO2 displays in flashing red when greater than this value. (Default 1.65)

OC Deco. PPO2

The decompression predictions (TTS and NDL) will assume that the gas in use at a given depth is the gas with the highest PPO2 that is less than or equal to this value. Also, the suggested gas switches (when the current gas is displayed in yellow) are determined by this value. If you change this value, please understand its effect. For example, if lowered to 1.50, then oxygen (99/00) will not be assumed at 20ft/6m. (Default 1.61)

CC Min. PPO2

PPO2 displays in flashing red when less than this value. (Default 0.40)

CC Max. PPO2

PPO2 displays in flashing red when greater than this value. (Default 1.60)

Note: In both OC and CC mode, a “Low PPO2” or “High PPO2” alert is displayed when the limits are violated for more than 30 seconds.

You Tube

Watch the video:
[Update Firmware](#)

FIRMWARE UPLOAD

Bluetooth communications are used for both Firmware Uploading and Dive Log Downloading.

NOTE: Upgrading the firmware resets decompression tissue loading. Plan repetitive dives accordingly.

Ensure that you have the latest version of Shearwater Desktop. You can get it by [clicking here](#)

In Shearwater Desktop, go to **Dive Computer** ➔ **Update Firmware**

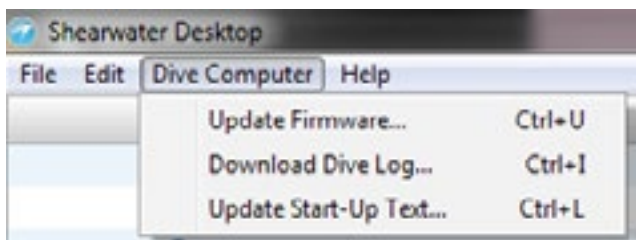

On your Perdix, navigate to **System Setup** ➔ **System Setup** ➔ **Load Upgrade**

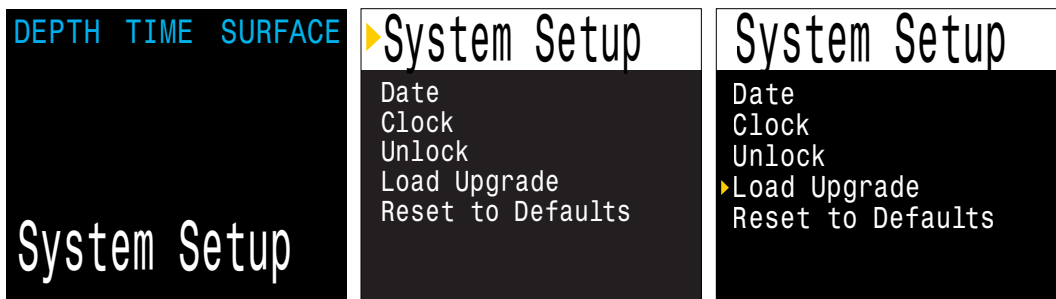

Shearwater Desktop will detect your Perdix and select the latest available firmware.

!

WARNING

During the update process, the screen may flicker or go blank for a few seconds. Do not remove the battery during the upgrade process.

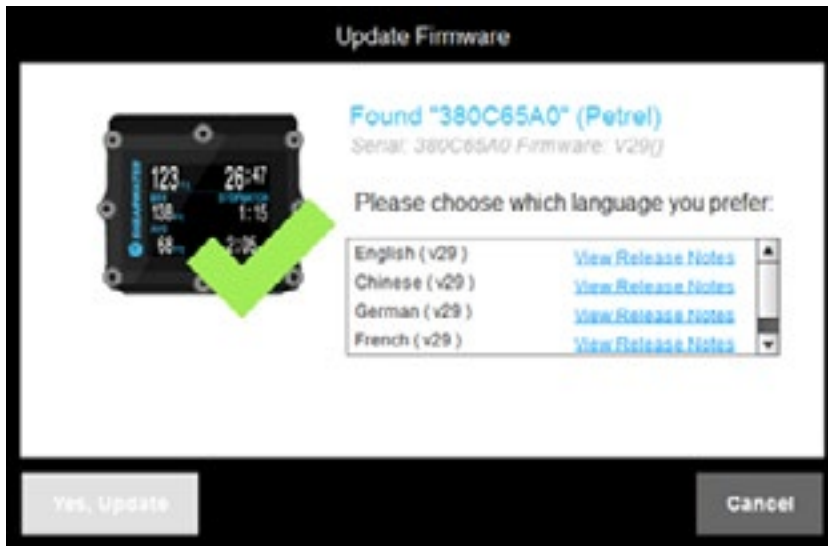

Choose your language, then press **“Yes, Update”** to install the latest firmware.



After that, Shearwater Desktop will send the firmware update to your Perdix.

The Perdix screen will give percentile updates of receiving the firmware, and then the Personal Computer will read “Firmware successfully sent to the computer”.

After receiving the new firmware, the Perdix will reset and display a message stating either firmware update success or failure.

Changing Languages

If you have chosen a language other than English, you will be asked to select the language you want to use when you start your Perdix the first time.

If you want to change the language, take out the battery briefly, and the next time you start your Perdix, you will be asked to select the language.

DIVE LOG DOWNLOAD

Bluetooth communications are used for both Firmware Uploading and Dive Log Downloading.

In Shearwater Desktop, go to **Dive Computer** ➔ **Download Dive Log**

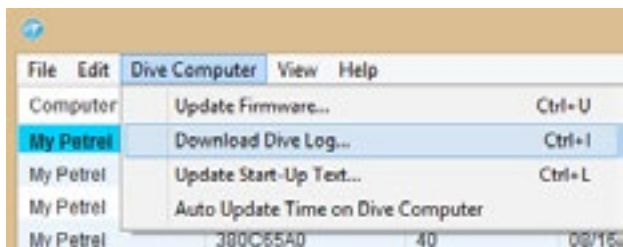

The Download Dive Log window should pop up.

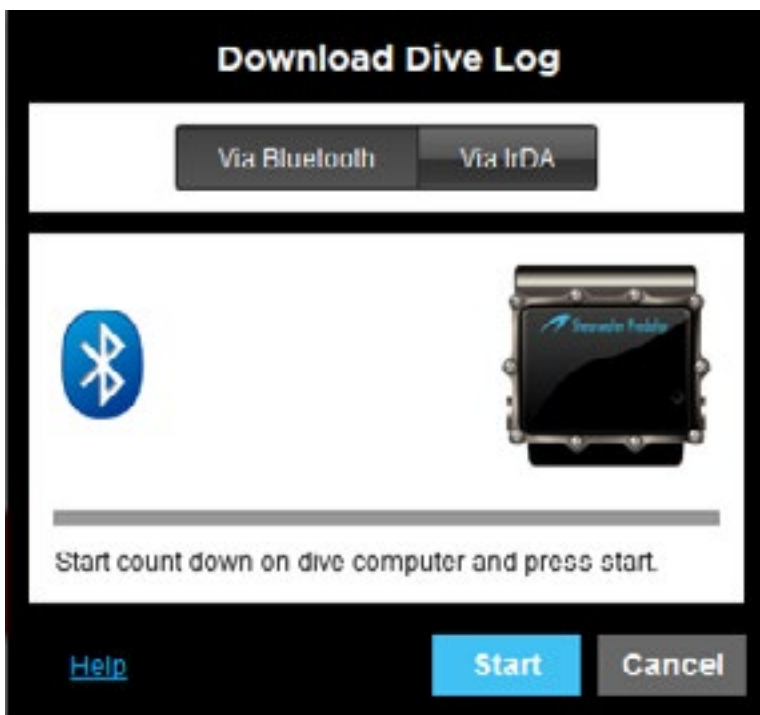

On your Perdix, navigate to **Dive Log** ➔ **Upload Log** ➔ **Upload**

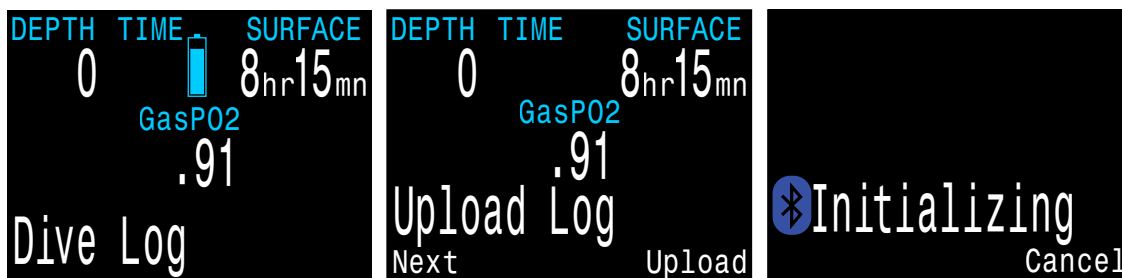



Now go back to Shearwater Desktop. Click start from the open “Download Dive Log” box. The PC will then connect to the Perdix.

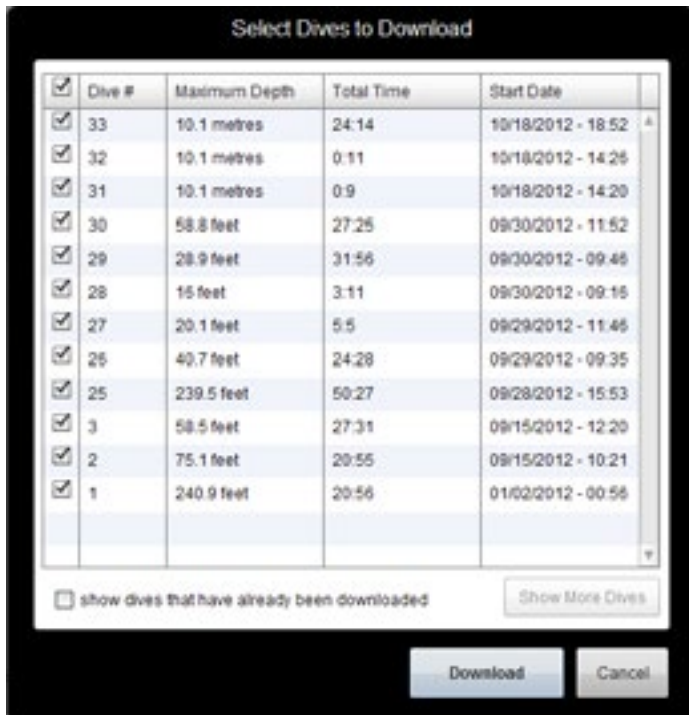

Once connected it will download a list of available dive logs and you will see a screen like this.

You can unselect any dive logs you don't want to download, or you can press “Download” to download all the dives on your Perdix. After that, Shearwater Desktop will transfer the dives to your computer.

The first time you download dives from your Perdix, you will be asked to give the Perdix a name. If you have multiple Shearwater dive computers, you will be able to easily tell which dive was downloaded from which dive computer.

CHANGING THE BATTERY

NOTE: A large coin or washer is required for this section.

Remove the battery cap

Insert the coin or washer into the battery cap slot. Unscrew by turning counter clockwise until the battery cap is free. Be sure to store the battery cap in a clean dry space.

Exchange the battery

Remove the existing battery by tilting the Perdix computer. Insert the new battery positive contact first. A small diagram on the bottom of the Perdix shows the proper orientation.

Accepted battery types

The Shearwater Perdix can accept a wide variety of AA sized batteries. The Perdix can accept any AA sized (or 14500 size) battery that outputs a voltage between 0.9V and 4.3V.

Reinstalling the battery cap

It is very important that the battery cap O-rings are clear of dust or debris. Carefully inspect your O-ring for any debris or damage and gently clean. It is recommended that you lubricate your battery cap's O-ring on a regular basis with an O-ring lubricant compatible with Buna-N (Nitrile) O-rings. Lubricating helps ensure that the O-ring seats properly and does not twist or bunch.

Insert the battery cap into the Perdix and compress the battery contact springs. While the springs are compressed rotate the battery cap clockwise to engage the threads. Be sure not to cross thread the battery cap's threads. Tighten the battery cap until snug and the Perdix powers on. Do not over tighten the battery cap.

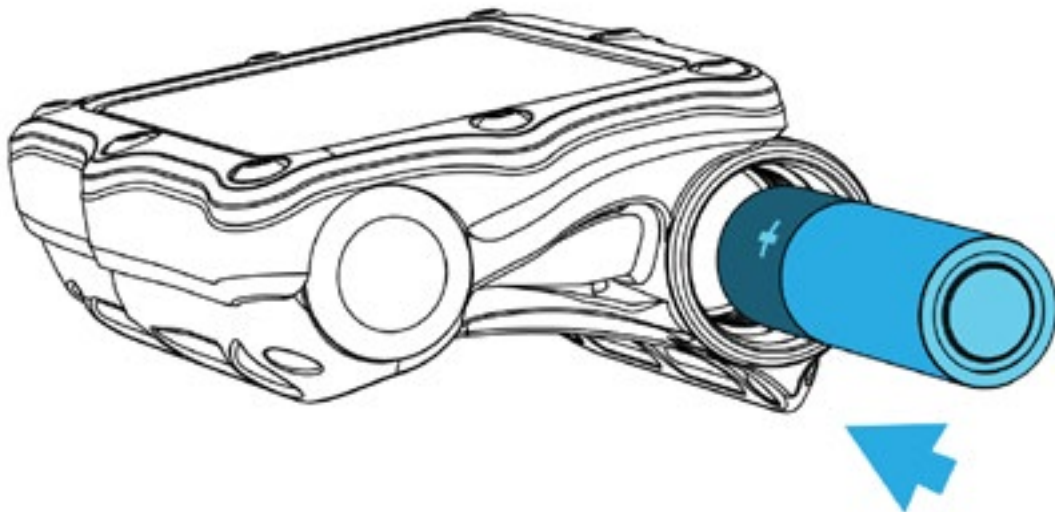

BATTERY TYPES

After changing the battery, a screen will prompt for the battery type to be entered.

The Perdix attempts to guess what type of battery is being used. If the battery type is incorrect, it should be manually edited.

Having the battery type set correctly is important so that the Perdix can give low battery warnings at the proper voltage levels.

Supported battery types are:

1.5V Alkaline: The common AA battery type that can be purchased at most supermarkets and electronics stores around the world. Not rechargeable. Inexpensive and reliable, they provide 45 hours of operation. Recommended.



ALKALINE BATTERIES CAN LEAK!

Alkaline batteries are especially prone to leaking corrosive battery acid when completely discharged. Remove discharged batteries immediately, and do not store your Perdix for more than 2 months with an alkaline battery installed.

1.5V Photo Lithium: Fairly common, but more expensive than alkalines. They provide about 60 hours of operation. Common brand is the Energizer Ultimate Lithium. Not rechargeable. Good for use in very cold water. Recommended.

1.2V NiMH: Common rechargeable batteries used in digital cameras and photo flashes. Can have high self discharge. Provide about 30 hours of operation per charge. Can die quickly, so care should be taken to ensure sufficient charge prior to diving.

3.6V Saft: The Saft LS14500 lithium batteries provide very high energy density. However, their high cost makes other battery types a better choice for most users. Provide about 130 hours of operation. Can die quickly, so care should be taken to ensure sufficient charge prior to diving.

3.7V Li-Ion: Rechargeable 14500 Li-Ion batteries provide about 35 hours of operation per charge. Can be ordered from the internet. Have more gradual voltage drop as discharged, so easier to determine remaining capacity than NiMH rechargeables. Good in cold water.

NOTE: Battery operating lifetimes are given with screen on medium brightness and at room temperature. Higher brightness and lower temperature can reduce life. Lower brightness can increase life.

BEHAVIOR ON BATTERY CHANGE

Settings

All settings are retained permanently. No loss of settings occurs when changing the battery.

Clock

The clock (time and date) is saved to permanent memory every 16 seconds when the Perdix is on, and every 5 minutes when off. When the battery is removed, the clock stops running. Once the battery is replaced, the clock is restored to the last saved value (so it is best to remove the battery while the Perdix is on for lowest error).

Quick battery changes will not require any adjustment, but the time should be corrected if the battery is removed for more than a few minutes.

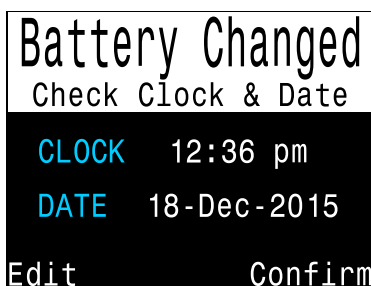

After replacing the battery a screen appears for quick adjustments to the time

The Perdix uses a highly accurate quartz crystal for time keeping. Expected drift is about 1 minute per month. If you notice higher drift, it is likely due to clock stoppage during battery changes, and is easily corrected at the time of a battery change (see image above).

Decompression tissue loading

The battery may be safely changed between repetitive dives.

Like the clock, the decompression tissue loading is saved every 16 seconds to permanent memory when on, and every 5 minutes when off.

When the battery is removed the tissues remain stored in the permanent memory and are restored once the battery is replaced, allowing for battery changes between repetitive dives. However, the Perdix does not know for how long the battery was removed, so no surface interval adjustment is applied for the time that the battery is removed.

For quick battery changes, the un-powered time interval is not significant. However, if the battery is removed shortly after a dive and then remains out for a long period, then residual tissue loading will remain when the battery is replaced. If you have not been diving for more than 4 days, it is safe to reset the tissues to their default levels (System Setup->Reset to Defaults->Tissues Only). Otherwise, just leave the tissues as is and accept the slightly higher conservatism for the next dive.

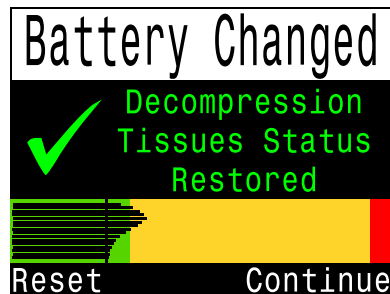

After a battery change the restored tissues are shown (with shortcut to reset)

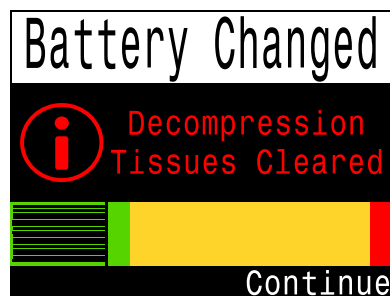

Resetting the deco tissues sets them to saturated with air at the current atmospheric pressure

If at time of battery replacement any tissue is below saturated with air at the current pressure, then that tissue is brought up to being saturated with air. This might happen after a decompression dive that used 100% O₂, where the faster tissues are often completely depleted of inert gas loading. Bringing such tissues back up to saturated with air after a battery change is the most conservative approach.

When deco tissues are reset, the following are reset:

- **Inert gas tissue loadings set to saturated with air at current atmospheric pressure**
- **CNS Oxygen Toxicity set to 0%**
- **Surface Interval time set to 0**
- **All VPM-B values set to default levels**



LIMITATIONS OF ALARMS

All alarm systems share common weaknesses.

They can alarm when no error condition exists (false positive). Or they can fail to alarm when a real error condition occurs (false negative).

So by all means respond to these alarms if you see them, but **NEVER** depend on them. Your judgement, education, and experience are your best defenses. Have a plan for failures, build experience slowly, and dive within your experience.

ERROR DISPLAYS

The system has several displays that alert to error conditions.



LIMITATIONS OF ALARMS

All alarm systems share common weaknesses. They can alarm when no error condition exists (false positive). Or they can fail to alarm when a real error condition occurs (false negative).

So by all means respond to these alarms if you see them, but NEVER depend on them. Your judgement, education, and experience are your best defenses. Have a plan for failures, build experience slowly, and dive within your experience.

Each of the alarms will display the message in yellow until dismissed. The error is dismissed by pressing the SELECT (right) button.

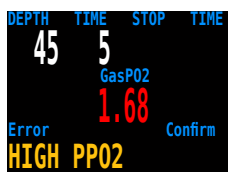

For example, this message will appear if the average **PPO2** goes **above 1.65** for more than 30 seconds.

Other errors you may encounter are shown in the table below.

Highest priority error is listed first. if multiple errors occur simultaneously, the error with the highest priority will be displayed. Clear that error by pressing the SELECT (right) button to see the next error.

Error	Description	Solution
Low PPO2	The PPO2 is below the limit set on the Adv. Config. page (default 0.19)	Change your breathing gas to one safe for the current depth.
High PPO2	The PPO2 is above the limit set on the Adv. Config. page (default 1.65)	Change your breathing gas to one safe for the current depth.
Missed Stop	A required decompression stop was violated.	Descend to deeper than the currently displayed stop depth. Monitor for symptoms of DCS. Use extra conservatism for future repetitive dives.

Error	Description	Solution
Fast ascent	The ascent was sustained at faster than 10m/min (33 feet/min).	Use a slow ascent rate. Monitor for symptoms of DCS. Use extra conservatism for future repetitive dives.
Tissues Cleared	The decompression tissue inert gas loading has been set to default levels.	Plan repetitive dives accordingly.
Low Battery Int.	The internal battery is low.	Replace the battery.
High CNS	Central Nervous System (CNS) toxicity clock high exceeded 90%.	Switch to a gas with a lower PPO2 or ascend shallower (decompression ceiling allowing).
Watchdog Reset	The computer has reset to recover from an unexpected software condition.	Please report to Shearwater Research Inc.
Reset to Defaults	Not really an error, just notification that the reset has been completed.	N/A
New Unlock	Not really an error, just notification that a new unlock has been applied.	N/A
Upgrade Failed	Firmware update failed, possibly due to a communications error or corrupted file.	Try the firmware upgrade again. Contact Shearwater if problem persists.
Various other system level errors	Other messages than those above may be shown for system level failures.	Please report to Shearwater Research Inc.

The center row also shows permanent "Low PPO2" or "High PPO2" messages when the PPO2 is not in a safe range. These message will clear automatically once a safe PPO2 is restored.



Sample Errors on Center Row

TROUBLESHOOTING

Symptom	Troubleshooting
Time of day is not accurate	The Perdix uses a highly accurate quartz crystal for time keeping. Expected drift is about 1 minute per month. If you notice higher drift, it is likely due to clock stoppage during battery changes. Adjust the time in the System menu.
Battery life is short	Ensure the battery type setting is correct. The battery gauge will not function correct if the setting does not match the actual. This can be adjusted when the battery is changed.
Battery dies without warning	Ensure the battery type setting is correct. The battery gauge will not function correct if the setting does not match the actual. This can be adjusted when the battery is changed.

STORAGE AND MAINTENANCE

The Perdix dive computer should be stored dry and clean.

Do not allow salt deposits to build up on your dive computer. Wash your computer with fresh water to remove salt and other contaminants. Do not use detergents or other cleaning chemicals as they may damage the Perdix dive computer. Allow to dry naturally before storing.

Do not wash under high pressure jets of water as it may cause damage to the depth sensor.

Store the Perdix dive computer out of direct sunlight in a cool, dry and dust free environment. Avoid exposure to direct ultra-violet radiation and radiant heat.

SERVICING

There are no user serviceable parts inside the Perdix.

Do not tighten or remove the faceplate screws.

Clean with water ONLY. Any solvents may damage the Perdix dive computer.

Service of the Perdix may only be done at Shearwater Research, or by any of our authorized service centers.

Your nearest service center can be found at www.shearwater.com

ERROR DISPLAYS

The system has several displays that alert an error condition.

Each of the alarms will display the message in **yellow** until dismissed. The error is dismissed by pressing SELECT.

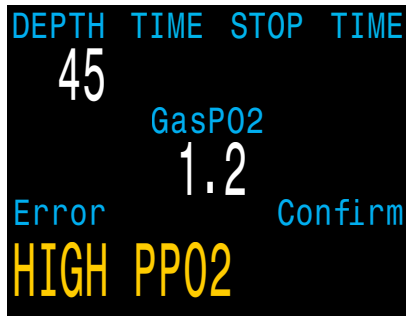

PPO2

This message will appear if the average PPO2 goes above 1.6 for more than 30 seconds.

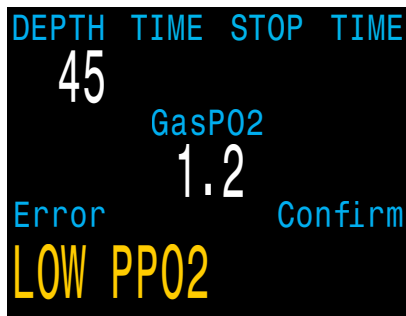

This message will appear if the average PPO2 goes below 0.4 (.19 for OC or SC) for more than 30 seconds.

It is not unusual to get this error immediately after submerging with a manual CCR and a hypoxic mix. The first breath after submerging floods the loop with low PPO2 gas. The situation is usually resolved by increasing depth such that when the error is noticed, the PPO2 is no longer low.

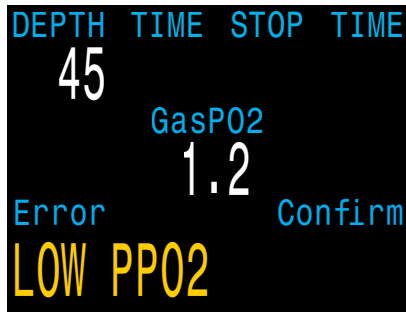

This condition will also cause the “LOW PPO2” display to appear. Here, the computer does not have two sensors that have confirming values. There is no way to know the actual PPO2, and the average PPO2 will be calculated as 0.11 (the lowest value is the most conservative for decompression calculations).

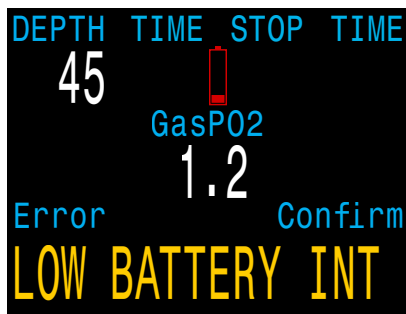

Battery

This message will appear when your internal battery is low for 30 seconds. The battery needs to be changed. The computer will also flash the battery symbol red.

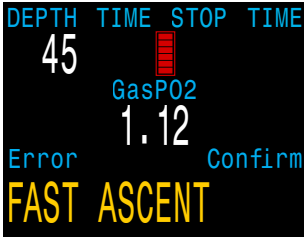

Ascent

This alarm is a notification that there has either been a very fast ascent for a short period of time, or that there has been an ascent of more than 66 fpm / 20 mpm maintained for over a minute. This alarm may return after being dismissed if the condition occurs again.

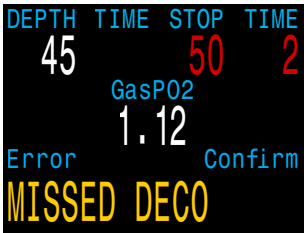

Deco

The alarm occurs when the diver has been above the minimum depth for a decompression stop for more than one minute. This alarm will only appear once during a dive, but it will also appear once on the surface after the dive.

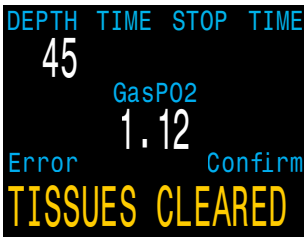

Tissues Cleared

This alarm will show when the decompression tissues are cleared. All decompression information has been lost.



Watchdog Reset

This alarm happens when the computer does not complete all of its tasks in the time allotted. It can happen occasionally from a transient problem like a battery bounce after an impact. It can also be the result of a hardware problem.

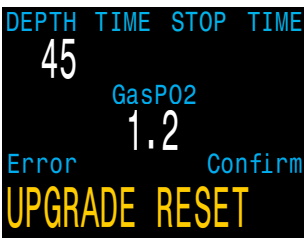

Upgrade Reset

This reset shows up after a software update. This is the normal event that shows the computer has been rebooted after the software update.

The center row also shows permanent "Low PPO2" or "High PPO2" messages when the PPO2 is not in a safe range. These message will clear automatically once a safe PPO2 is restored.

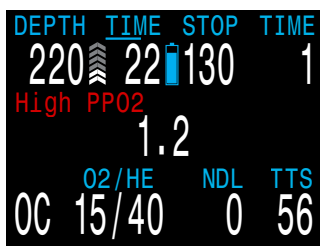
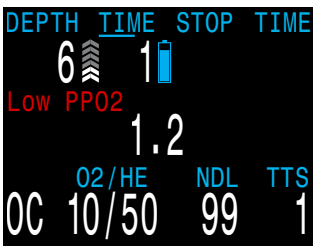

CONTACT SHEARWATER

This is not an exhaustive list. Please contact us if you experience any unexpected errors:
info@shearwater.com

Sample errors on center row

STORAGE AND MAINTENANCE

The Perdix dive computer should be stored dry and clean, and without batteries installed.

Do not allow salt deposits to build up on your dive computer. Wash your computer with fresh water to remove salt and other contaminants. **Do not use detergents or other cleaning chemicals** as they may damage the Perdix dive computer. Allow to dry naturally before storing.

Do not wash under high pressure jets of water as it may cause damage to the depth sensor.

Store the Perdix dive computer **out of direct sunlight** in a cool, dry and dust free environment. Avoid continuous exposure to direct ultra-violet radiation and radiant heat.

Servicing

- 🔧 There are no user serviceable parts inside the Perdix.
- 🔧 Do not tighten or remove the faceplate screws.
- 🔧 Clean with water ONLY. Any solvents may damage the dive computer.
- 🔧 Service of the Perdix may only be done at Shearwater Research, or by any of our authorized service centers.
- 🔧 Your nearest service center can be found at www.shearwater.com/contact

SPECIFICATIONS

Specification	Perdix Model
Operating Modes	OC Tec OC Rec OC/CC (internal PPO2) Gauge
Decompression Model	Bühlmann ZHL-16C with GF VPM-B and VPM-B/GFS (optional)
Display	Full color 2.2" QVGA LCD with always on LED backlight
Pressure (depth) sensor	Piezo-resistive
Calibrated Range	0 Bar to 14 Bar
Accuracy	+/-20 mBar (at surface) +/-100 mBar (at 14bar)
Crush Depth Limit	27 Bar (~260msw)
Surface Pressure Range	500 mBar to 1040 mBar
Depth of dive start	1.6 m of sea water
Depth of dive end	0.9 m of sea water
Operating Temperature Range	+4°C to +32°C
Short-Term (hours) Temperature Range	-10°C to +50°C
Long-Term Storage Temperature Range	+5°C to +20°C
Battery	AA Size, 0.9V to 4.3V User replaceable
Battery Operating Life (Display Medium Brightness)	45 Hours (AA 1.5V Alkaline) 130 Hours (SAFT LS14500)
Communications	Bluetooth Smart Ready
Compass Resolution	1°
Compass Accuracy	35°
Compass Tilt Compensation	Yes, over 345° pitch and roll
Dive Log Capacity	Approximately 1000 hours
Battery cap o-ring	Dual o-rings. Size: AS568-112 Material: Nitrile Durometer: 70A
Wrist Attachment	2 x 3/4" Elastic Straps with Buckles, or 2 x Bungee Cord (3/16" diameter cord)
Weight	152 g
Size (W X L X H)	81mm X 71mm X 38mm

FCC WARNING

a) USA-Federal Communications Commission (FCC)

This equipment has been tested and found to comply with the limits for a Class B digital device, pursuant to Part 15 of FCC Rules. These limits are designed to provide reasonable protection against harmful interference in a residential installation. This equipment generates, uses, and can radiate radio frequency energy. If not installed and used in accordance with the instructions, it may cause harmful interference to radio communications. However, there is no guarantee that interference will not occur in a particular installation.

If this equipment does cause harmful interference to radio or television reception, which can be determined by tuning the equipment off and on, the user is encouraged to try and correct the interference by one or more of the following measures:

- Reorient or relocate the receiving antenna
- Increase the distance between the equipment and the receiver.
- Connect the equipment to outlet on a circuit different from that to which the receiver is connected.
- Consult the dealer or an experienced radio/TV technician for help.

Any changes or modifications not expressly approved by the party responsible for compliance could void the user's authority to operate the equipment.

Caution: Exposure to Radio Frequency Radiation.

This device must not be co-located or operating in conjunction with any other antenna or transmitter. **Contains TX FCC ID: T7VEBMU**

INDUSTRY CANADA WARNING

b) Canada - Industry Canada (IC)

This device complies with RSS 210 of Industry Canada.

Operation is subject to the following two conditions:

- (1) this device may not cause interference, and
- (2) this device must accept any interference, including interference that may cause undesired operation of this device.

L'utilisation de ce dispositif est autorisée seulement aux conditions suivantes :

- (1) il ne doit pas produire d'interférence, et
- (2) l'utilisateur du dispositif doit être prêt à accepter toute interférence radioélectrique reçue, même si celle-ci est susceptible de compromettre le fonctionnement du dispositif.

Caution: Exposure to Radio Frequency Radiation.

The installer of this radio equipment must ensure that the antenna is located or pointed such that it does not emit RF field in excess of Health Canada limits for the general population; consult Safety Code 6, obtainable from Health Canada's [website](#).

Contains TX IC: 216QEbzMU

CONTACT

Shearwater Research Inc.

Headquarters

13155 Delf Place, Unit 250
Richmond, BC
V6V 2A2
Tel: +1.604.669.9958
info@shearwater.com

EU Service Center

Narked at 90 Ltd

109 Irthlingborough Rd
Finedon, Northamptonshire
NN9 5EJ, UK
Tel: +44.1933.681255
info@narkedat90.com

US Rep & Service Center

Curt McNamee

1316 142nd PL SE
Mill Creek, WA
98012, US
Tel: +1.425.418.1425
flyingcash@gmail.com

Asia/Pac Rep & Service Center

Paul Trainor (Underwater Obsession)

287 Happy Valley Road
Owhiro Bay, Wellington
6023, NZ
Tel: +64.27.6128265
paul@technicaldiving.co.nz



www.shearwater.com



www.facebook.com/DiveShearwater



www.twitter.com/DiveShearwater

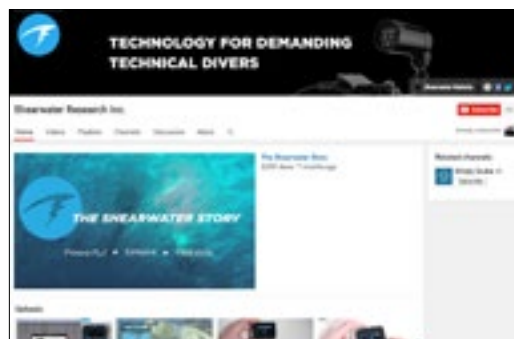

www.youtube.com/shearwaterresearch



OPERATING INSTRUCTION MANUAL

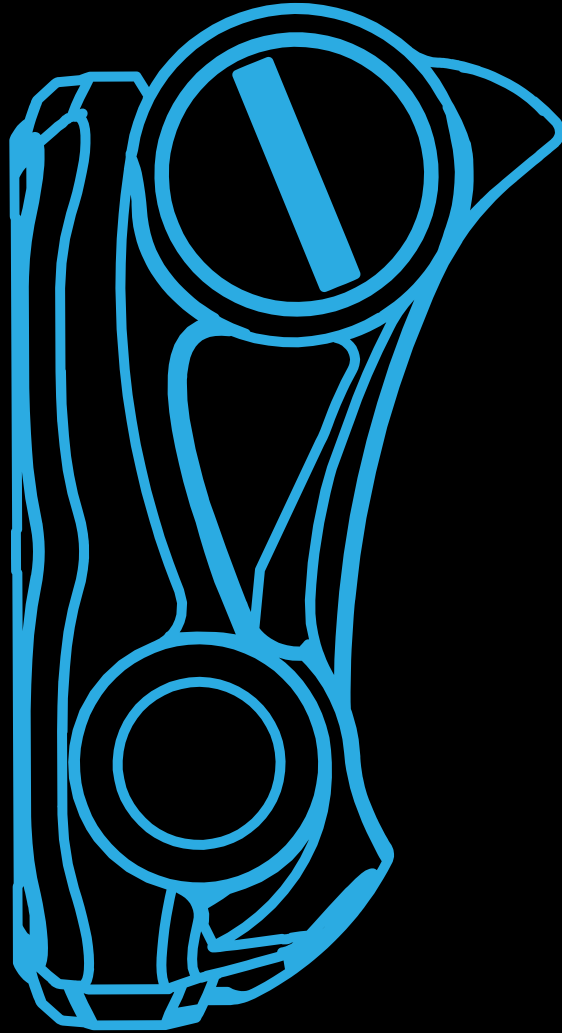

Powerful • Simple • Reliable

www.shearwater.com